

SINGER
22W57, W58, W155, W156

Form 1709w
February, 1921

LIST OF PARTS



MACHINES
Nos. 22w57, 22w58,
22w155 and 22w156

THE SINGER MANUFACTURING COMPANY

COPYRIGHT, U. S. A., 1918, 1919 AND 1921
BY
THE SINGER MANUFACTURING CO.
ALL RIGHTS RESERVED FOR ALL COUNTRIES

INDEX

	PAGE
ACCESSORIES	28
BOBBIN WINDER	28
FEED DOGS	33
FOOT LIFTER	31, 32
KNEE LIFTER	29, 31
MACHINE No. 22w57	7
“ “ 22w58	17
“ “ 22w155	18
“ “ 22w156	27
NUMERICAL LIST OF PARTS	37
OBSOLETE PARTS	36
ROLLER PRESSERS	33
THREAD UNWINDER	30
THROAT PLATES	35

From the library of Diamond Needle Corp

Instructions for Ordering

In ordering from this list, use **ONLY** the **PART** number in the **FIRST** column.

The number stamped on a Sewing Machine Part is the number of the Single Part only, except when the part includes Set Screws, Clamping Screws, Studs and Rollers Spun on, Small Wires riveted, or Parts soldered together, etc., which it is necessary to furnish in combination.

Every combination of parts sent out has its specific number which, although not stamped on Parts (except in above cases) must be used when ordering the combination.

Each number always indicates the **SAME PART** in whatever list it appears, or for whatever Machine.

The letters after some of the numbers indicate the style of finish only, as follows:

- A. Hardened, Polished and Plated.
- B. Polished and Plated.
- C. Hardened only.
- D. Polished only.
- E. Soft, not polished.
- F. Hardened and Polished.
- H. Blued.

These letters **MUST BE USED** when they appear in the list and **AFTER** the number, as in the list.

In this series

200001 to 201500 are Screw Numbers.

201501 to 201800 are Nut Numbers.

201801 to 202000 are Roller Numbers.

202001 and upward are numbers of Machine Parts.

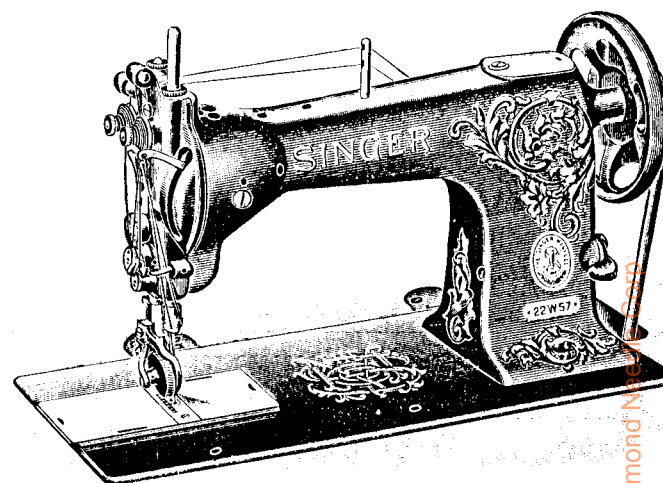
The figures in the second column refer only to the plate in which the illustration of the part is shown and are **NOT TO BE USED** in ordering.

Two or more numbers over a cut indicate that the difference between such parts is not visible in an illustration.

Parts marked with an asterisk (*) are furnished only when repairs are made at the factory.

LIST OF PARTS COMPLETE

FOR



MACHINE No. 22w57

DROP FEED, ROLLER PRESSER

For Vamping, Foxing, Stitching Gloves, Etc.

In gauges from $\frac{31}{64}$ to $\frac{36}{64}$ inch.

No.	Plate	Name
*204161	---	Arm with 200439c, 202036 and 204705
204163	12305	Arm Cap
200278u	12311	" " Screw
202248	12307	" " " Washer
204235	13045	" Position Pin (2)
200963E	12311	" Screw (3)
202005	12308	" " Washer (3)
203202	12333	" Shaft
204705	12334	" " Bushing (front)
200439c	12311	" " " Position Screw
204440	12333	" " Connection with four 200054E (2)
200054E	12307	Arm Shaft Connection Screw
202299	---	" " Oil Packing (wick) (2)
204805	12333	Balance Wheel, 5 $\frac{1}{2}$ in. diam. (belt groove 2 $\frac{3}{4}$ in. diam.), with 200328c and 200335c

No.	Plate	Name
200062H	12311	Balance Wheel Adjusting Screw ...
200328C	12311	" " Position Screw
200335C	12311	" " Set Screw
*203300	—	Bed with 202062, 203248, 203249, two each 200362C, 200516E, 200840E and 202299
202258	13105	Bed Hinge Connection (2)
200570E	12311	" " " Screw (4)
203329	11886	" Slide (back)
203301	12334	" " (front)
203470	11249	Bobbin
*203498	—	" Case
203648	13104	" " Latch
*202056	—	" " " Pin
203473	13104	" " " Plunger
203474	13104	" " " Spring
203499	11249	" " Lever
203476	—	" " " Eccentric
204243	13105	" " " Position Pin
203506	11249	" " " Fulcrum
200056D	10882	" " " " Screw
203478	11249	" " " Slide Stud
203214	13045	" " " Tension Spring
200984C	13045	" " " " Regulat- ing Screw
200594C	13045	Bobbin Case Tension Spring Screw
203216	—	" " Washer (cloth)
203500	11249	Bobbin Case complete, Nos. 200594C, 200984C, 202056, 203214, 203216, 202473, 202474, 203498 and 203648
204533	12333	Face Plate with 200366H, 204730, two each 200368H, 202090, 204281 and three 200397H
200053C	12311	Face Plate Screw
204730	13105	" " Thread Guide
200397H	12309	" " " " Set Screw
204534	—	Face Plate complete, Nos. 200113E, 200135C, 200319C, 200577H, 204277 to 204280, 204330, 204533, 204555, two each 200309E, 204059 and 204272
203303	12334	Feed Bar with 204189
203309	—	" " 203303 with 200214E, 201525E and 204200
200214E	13105	Feed Bar Hinge Screw
201525E	13105	" " " " Nut
214424	13105	" " Spring
204189	12306	" " " Hook
212103	13106	" Dog, for 212178

No.	Plate	Name
200106E	12311	Feed Dog Screw (2)
200075E	13105	" " Support Screw
201535E	13105	" " " " Nut
203233	12305	" Driving Cam with 200382C and 200437E
204192	—	Feed Driving Cam Fork Lever with 204195 and 204293
204193	12334	Feed Driving Cam Fork Lever Con- nection with 200668C and 201525E
204194	12306	Feed Driving Cam Fork Lever Con- nection Clamp with 200031E
200031E	12311	Feed Driving Cam Fork Lever Con- nection Clamp Pinch Screw
200668C	13105	Feed Driving Cam Fork Lever Con- nection Clamp Screw Stud
201525E	13105	Feed Driving Cam Fork Lever Con- nection Clamp Screw Stud Nut
200002E	12338	Feed Driving Cam Fork Lever Con- nection Hinge Screw
201522E	12338	Feed Driving Cam Fork Lever Con- nection Hinge Screw Nut
*204195	—	Feed Driving Cam Fork Lever Shaft
204197	12306	Feed Driving Cam Fork Lever Shaft Collar with 200113E
200113E	12225	Feed Driving Cam Fork Lever Shaft Collar Set Screw
204293	12308	Feed Driving Cam Fork Lever Shaft Position Screw
204196	12307	Feed Driving Cam Fork Lever Shaft Sleeve (split)
200043C	12311	Feed Driving Cam Fork Lever Shaft Sleeve Set Screw
201524E	12338	Feed Driving Cam Fork Lever Shaft Sleeve Set Screw Nut
204198	12334	Feed Driving Cam Fork Lever com- plete, Nos. 204192 and 204194 ...
200437E	12311	Feed Driving Cam Position Screw
200382C	13045	" " " Set Screw
204199	12333	" " Rock Shaft
206554	—	" " " " 2 0 4 1 9 9 with 200002E, 201522E and 204193
202305	12307	Feed Driving Rock Shaft Center (2)
200043C	12311	" " " " " Set Screw (2)
204200	12305	Feed Driving Rock Shaft Crank with 204189 (on left side) and two 200383C
200383C	12311	Feed Driving Rock Shaft Crank Set Screw

From the library of: Diamond Needle Corp

No.	Plate	Name
213007	13104	Feed Lifting Cam with 202126
204202	12308	" " " Fork with 200027E
200027E	12338	" " " " Pinch Screw
202126	12308	" " " Position Pin
200045E	12338	" " " Screw
203305	12334	" " Rock Shaft
203315	12334	" " " " 203305 with 203238
202305	12307	Feed Lifting Rock Shaft Center (2)
200043C	12311	" " " " " Set Screw (2)
202276	12308	Feed Lifting Rock Shaft Slide Block
203238	12308	" " " " " " " 292276 with 200243E and 201531E
200243E	12338	Feed Lifting Rock Shaft Slide Block Hinge Screw
201531E	12308	Feed Lifting Rock Shaft Slide Block Hinge Screw Nut
204206	12306	Feed Regulating Handle
204207	12334	" " " 204206 with 200098E, 202622, 204208 to 204210, 204213 and 204925
204208	12307	Feed Regulating Handle Adjustable Stop
200098E	12307	Feed Regulating Handle Adjustable Stop Screw
204925	12306	Feed Regulating Handle Adjustable Stop Screw Washer
204209	12307	Feed Regulating Handle Position Pin
204210	12306	Feed Regulating Handle Shaft
204211	12306	" " " " Crank with 200098E
204212	12307	Feed Regulating Handle Shaft Crank Link
200271C	12311	Feed Regulating Handle Shaft Crank Link Hinge Screw (lower)
200291E	12307	Feed Regulating Handle Shaft Crank Link Hinge Screw (upper)
200098E	12307	Feed Regulating Handle Shaft Crank Set Screw
204213	12307	Feed Regulating Handle Shaft Sleeve (split)
200362C	12311	Feed Regulating Handle Shaft Sleeve Set Screw
202622	12306	Feed Regulating Handle Shaft Sleeve Washer
202036	12338	Feed Regulating Handle Stop Pin

No.	Plate	Name
204214	---	Feed Regulating Handle complete, Nos. 200291E, 204207, 204211 and 204212
*203482	---	Hook (sewing)
203483	11249	" 203482 with 201253E, 201376E and 203251
203503	13104	Hook and Bobbin Case complete, Nos. 203483 and 203500
213810	11249	Hook Bevel Gear Socket, 24 teeth
200555H	11007	" " " " Screw . . .
203242	11007	" " Pinion, 24 teeth, with two 200383c
200383c	12311	Hook Bevel Pinion Set Screw
203306	12333	" Counter Shaft
203244	11007	" " " Collar with two 200393c
200393c	11007	Hook Counter Shaft Collar Set Screw
203245	11007	Hook Counter Shaft Driving Gear, 44 teeth, with 200362c and 200439c
213157	---	Hook Counter Shaft Driving Gear 203245 with 200045E and 213007
200439c	12311	Hook Counter Shaft Driving Gear Position Screw
200362c	12311	Hook Counter Shaft Driving Gear Set Screw
203246	11007	Hook Counter Shaft Gear, 22 teeth, with two 200383c
200383c	12311	Hook Counter Shaft Gear Set Screw
202299	---	" " " Oil Packing (wick)
200840E	11007	Hook Counter Shaft Oil Packing (wick) Stop Screw
203247	12333	Hook Driving Shaft
203248	12334	" " " Bearing with 202299
202299	---	Hook Driving Shaft Bearing Oil Packing (wick)
202126	12308	Hook Driving Shaft Bearing Posi- tion Pin
200516E	12311	Hook Driving Shaft Bearing Screw
203249	11007	" " " Bushing (eccen- tric)
202299	---	Hook Driving Shaft Bushing Oil Packing (wick)
200362c	12311	Hook Driving Shaft Bushing Set Screw
213141	13045	Hook Driving Shaft Collar with two 200393c

No.	Plate	Name
200393c	11007	Hook Driving Shaft Collar Set Screw
203251	13104	Hook Gib
201376F	13045	" " Hinge Screw
201253F	13045	" " Screw
203508	11249	" Saddle (left or right) with 200056D
200006E	11007	Hook Saddle Screw (4)
202622	12306	" " Washer (4)
213018	----	" Washer
203507	11249	" " 213018 with 203476 and two 204243
203509	11249	Hook Saddle (left or right) complete, Nos. 200555U, 203478, 203499, 203503, 203506 to 203508 and 213810
203510	----	Hook Saddle Combination (left and right) complete, Nos. two 203509
202445	11125	Knee Lifter Connection Lever with 202446
227311	----	Knee Lifter Connection Lever 202445 with 200224U, 200262U, 227309 and 227308
200224U	12306	Knee Lifter Connection Lever Hinge Screw
227308	11125	Knee Lifter Connection Lever Lifting Rod with 202302
202302	12306	Knee Lifter Connection Lever Lifting Rod Cotter Pin
202446	12306	Knee Lifter Connection Lever Pin
227302	11125	" " Lifting Lever
200262H	12306	" " " " Hinge Screw
231390	11886	Needle Bar (hollow)
204248	12307	" " Connecting Link
200658c	12307	" " " " Hinge Screw Stud
201519c	12307	Needle Bar Connecting Link Hinge Screw Stud Nut
204249	12308	Needle Bar Connecting Stud with 200072c and 202277
202277	----	Needle Bar Connecting Stud Oil Packing (wick)
200072c	12308	Needle Bar Connecting Stud Pinch Screw
204326	12338	Needle Bar Packing Cord (2)
200504E	13105	" " Screw Bushing (lower)
200503B	13105	" " " " (upper)

No.	Plate	Name
231381	13106	Needle Holder, needles $\frac{3}{16}$ in. apart and must be set diagonally, in gauges $\frac{1}{16}$, $\frac{3}{16}$, $\frac{1}{4}$ and $\frac{5}{16}$ in., with 201030E and two 200141E
201030E	13105	Needle Holder Screw
200141E	12225	" Set Screw
204252	12308	Presser Bar Lifter
200550c	12311	" " " Hinge Screw
204253	12308	" " Lifting Bracket with 200086c
200086c	12308	Presser Bar Lifting Bracket Pinch Screw
204254	12307	Presser Bar Lifting Bracket Position Guide
200362c	12311	Presser Bar Lifting Bracket Position Guide Set Screw
204327	12306	Presser Bar Packing Washer (felt)
200504E	13105	" " Screw Bushing (lower)
204258	13045	" " Spring (heavy)
200491B	12305	" " Thumb Screw (pressure regulating)
201906	----	Roller Presser, $1\frac{1}{2}$ in. diam., $\frac{3}{8}$ in. face (fine), with 200548E and 201534U
202839	----	Roller Presser Arm
204567	----	" " " 202839 with 201906
229341	11748	Roller Presser Arm Bracket (swing)
229344	----	Roller Presser Arm Bracket 229341 with 200096D, 201071E, 204567 and 229325
200675c	12225	Roller Presser Arm Bracket Position Screw Stud
202558	12225	Roller Presser Arm Bracket Spring
229370	----	" " " " " " Stop and Back Needle Guard Holder
229371	11748	Roller Presser Arm Bracket Spring Stop and Back Needle Guard Holder 229370 with 200159E, 200350U and 226220
200350U	11748	Roller Presser Arm Bracket Spring Stop and Back Needle Guard Holder Adjusting Screw
200141E	12225	Roller Presser Arm Bracket Spring Stop and Back Needle Guard Holder Set Screw

No.	Plate	Name
200096D	12225	Roller Presser Arm Screw
204495	12225	" " Bar
200548H	13045	" " Hinge Screw
201534H	12225	" " " " Nut
229328	11748	" " Needle Guard (back), in gauges $\frac{3}{16}$, $\frac{1}{4}$, $\frac{5}{16}$ and $\frac{3}{8}$ inch
200159F	11748	Roller Presser Needle Guard (back) Clamp Screw
226220	11748	Roller Presser Needle Guard (back) Clamp Screw Washer ...
229325	11748	Roller Presser Needle Guard (front), in gauges from $\frac{3}{16}$ to $\frac{3}{8}$ in., in steps of $\frac{1}{16}$ inch
201071F	11748	Roller Presser Needle Guard (front) Screw
229345	13107	Roller Presser and Bar complete, in gauges $\frac{3}{16}$, $\frac{1}{4}$, $\frac{5}{16}$ and $\frac{3}{8}$ in., Nos. 200675C, 202558, 204495, 229328, 229344, 229371 and two 200141F
213006	13045	Take-up Cam with 200335C, 200383C, 200430C, 200658C and 201519C ...
203172	12307	Take-up Cam Friction Washer
200430C	12311	" " Position Screw
200383C	12311	" " " " Check Screw
200335C	12311	Take-up Cam Set Screw
203311	13104	" Lever
221454	---	" " 203311 with 204263 ...
204263	13104	" " Bearing with 204264..
204264	12306	" " " Position Pin...
200042F	12311	" " " Screw
201816	12307	" " Roller
203312	13104	Take-up Lever complete, Nos. 200042F, 201816 and 221454
202402	12309	Tension Disc
202090	12309	" " Position Pin
204555	12338	" Release Lever
200309F	12309	" " " Screw
202075	12309	" " Plunger
215609	---	" " Slide
204268	13104	" " " 215609 with 204269
204269	13104	" " " Spring
202407	10881	" Spring
200632B	12309	" Stud
200397H	12309	" " Set Screw
201572B	10881	" Thumb Nut
204271	12309	" Washer

No.	Plate	Name
204272	12309	Tension complete, Nos. 200632B, 201572B, 202075, 202407, 204271 and two 202402
204273	12308	Thread Controller Adjusting Collar with 200684H (for Presser Bar)
200684H	12308	Thread Controller Adjusting Collar Screw
204274	12309	Thread Controller Plate
200577H	12311	" " " Screw ...
202098	12309	" " Roller
204275	12309	" " " Guard
202084	12309	" " " Washer
200300C	12309	" " " Screw
204276	12309	" " Spring
204333	12309	" " " Guard
200581H	12309	" " " Screw
204277	12309	" " " Stop
204278	12309	" " " " Driv- ing Gear
200319C	12309	Thread Controller Spring Stop Driv- ing Gear Hinge Screw
200135C	12309	Thread Controller Spring Stop Screw
204279	12309	Thread Controller Spring Stud with 204925
200366H	12309	Thread Controller Spring Stud Set Screw
204925	12306	Thread Controller Spring Stud Washer
205987	12309	Thread Controller complete, Nos. 200300C, 200581H, 202084, 202098, 204274, 294275 and 204333
204280	12309	Thread Controller and Spring com- plete, Nos. 204276 and 205987 ...
204556	13105	Thread Guide
203313	13105	" "
204329	---	" Oiler (felt)
204330	12225	" " Bracket with 204329 ...
200113F	12225	" " " Screw
204281	12309	" Retainer Guide Wire
202091	12309	" " Sleeve
202092	12309	" " Spring
204058	12309	" " Stud
200368H	12309	" " " Set Screw ...
204059	12309	Thread Retainer complete, Nos. 202091, 202092 and 204058

No.	Plate	Name
212178	12154	Throat Plate, 53 elongated needle hole, needles $\frac{3}{32}$ in. apart, for needle sizes 14 and 15, in gauges $\frac{1}{16}$, $\frac{3}{16}$ and $\frac{1}{8}$ in., for 212103
200161D	12319	Throat Plate Clamp Screw
202062	12308	" " Position Pin
200577H	12311	" " Screw

MACHINE No. 22w58

DROP FEED, ROLLER PRESSER

For Vamping, Foxing, Stitching Gloves, Etc.

In gauges from $\frac{1}{16}$ to $\frac{1}{8}$ inch.

The same as Machine No. 22w57 with the following exceptions:

No.	Plate	Name
227307	13107	Foot Lifter Lifting Lever
227479	----	" " " " 227307 with 200262H
227320	----	Foot Lifter Lifting Lever 227479 with 227318, in place of 227311
200262H	12306	Foot Lifter Lifting Lever Hinge Screw
227308	11125	Foot Lifter Lifting Lever Rod with 202302
227318	----	Foot Lifter Lifting Lever Rod 207308 with 206628, 227227 and 227576
204126	----	Foot Lifter Lifting Lever Rod Clamp with two 200530c
227316	12388	Foot Lifter Lifting Lever Rod Clamp Hook
227576	12388	Foot Lifter Lifting Lever Rod Clamp Hook 227316 with 204126
200530c	13105	Foot Lifter Lifting Lever Rod Clamp Set Screw
202302	12306	Foot Lifter Lifting Lever Rod Cotter Pin
206628	12388	Foot Lifter Lifting Lever Rod Spring
227227	12388	Foot Lifter Lifting Lever Rod Spring Collar with 200113F
200113F	12225	Foot Lifter Lifting Lever Rod Spring Collar Set Screw

LIST OF PARTS COMPLETE
FOR
MACHINE No. 22w155

DROP FEED, ROLLER PRESSER

For Vamping, Foxing, Stitching Gloves, Etc.

In gauges from $\frac{1}{16}$ to $\frac{1}{8}$ inch.

No.	Plate	Name
*204290	—	Arm with 200439c, 202036 and 204705
204163	12305	Arm Cap
200278H	12311	" " Screw
202248	12307	" " " Washer
204235	13045	" Position Pin (2)
200963E	12311	" Screw (3)
202005	12308	" " Washer (3)
213622	12333	" Shaft
204705	12334	" " Bushing (front)
200439c	12311	" " " Position Screw ...
204440	12333	" " Connection with four 200054E (2)
200054E	12307	Arm Shaft Connection Screw
202299	—	" " Oil Packing (wick) (2)
204805	12333	Balance Wheel, $5\frac{1}{4}$ in. diam. (belt groove $2\frac{3}{4}$ in. diam.), with 200328c and 200335c
200062H	12311	Balance Wheel Adjusting Screw ..
200328c	12311	" " Position Screw
200335c	12311	" " Set Screw
*213052	—	Bed with 202062, 203248, 293249, two each 200362c, 200516E, 200840E and 202299
202258	13105	Bed Hinge Connection (2)
200570E	12311	" " " Screw (4) ...
203329	11886	" Slide (back)
203301	12334	" " (front)
203470	11249	Bobbin (2)
*203498	—	" Case
203648	13104	" " Latch
*202056	—	" " " Pin
203473	13104	" " " Plunger
203474	13104	" " " Spring

No.	Plate	Name
203499	11249	Bobbin Case Lever
203476	—	" " " Eccentric
204243	13105	" " " " Position Pin
203506	11249	" " " Fulcrum
200056b	10882	" " " " Screw
203478	11249	" " " Slide Stud
203214	13045	" " Tension Spring
200984c	13045	" " " " Regulat- ing Screw
200594c	13045	Bobbin Case Tension Spring Screw
203216	—	" " Washer (cloth)
203500	11249	Bobbin Case complete, Nos. 200594c, 200984c, 202056, 203214, 203216, 203473, 203474, 203498 and 203648
204533	12333	Face Plate with 200366H, 202090, 204281 and three 200397H
200053c	12311	Face Plate Screw
204730	13105	" " Thread Guide
200397H	12309	" " " " Set Screw
204534	—	Face Plate complete, Nos. 200113E, 200135c, 200319c, 200577H, 204277, to 204280, 204330, 204533, 204555, two each 200309E, 204059 and 204272
203303	12334	Feed Bar with 204189
203309	—	" " 203303 with 200214E, 201525E and 204200
200214E	13105	Feed Bar Hinge Screw
201525E	13105	" " " " Nut
214424	13105	" " Spring
204189	12306	" " " Hook
212103	13106	" Dog, for 212178
200106E	12311	" " Screw (2)
200075E	13105	" " Support Screw
201535E	13105	" " " " Nut
203233	12305	" Driving Cam with 200382c and 200437c
204192	—	Feed Driving Cam Fork Lever with 204195 and 204293
204193	12334	Feed Driving Cam Fork Lever Connection with 200668c and 201525E
204194	12306	Feed Driving Cam Fork Lever Connection Clamp with 200031E
200031E	12311	Feed Driving Cam Fork Lever Connection Clamp Pinch Screw
200668c	13105	Feed Driving Cam Fork Lever Connection Clamp Screw Stud
201525E	13105	Feed Driving Cam Fork Lever Connection Clamp Screw Stud Nut

No.	Plate	Name
200002E	12338	Feed Driving Cam Fork Lever Connection Hinge Screw
201522E	12338	Feed Driving Cam Fork Lever Connection Hinge Screw Nut
*204195	-----	Feed Driving Cam Fork Lever Shaft
204197	12306	Feed Driving Cam Fork Lever Shaft Collar with 200113F
200113F	12225	Feed Driving Cam Fork Lever Shaft Collar Set Screw
204293	12308	Feed Driving Cam Fork Lever Shaft Position Pin
204196	12307	Feed Driving Cam Fork Lever Shaft Sleeve (split)
200043C	12311	Feed Driving Cam Fork Lever Shaft Sleeve Set Screw
201524E	12338	Feed Driving Cam Fork Lever Shaft Sleeve Set Screw Nut
204198	12334	Feed Driving Cam Fork Lever complete, Nos. 204192 and 204194 ...
200437C	12311	Feed Driving Cam Position Screw
200382C	13045	" " " " Set Screw
204294	12333	" " " " Rock Shaft
206555	-----	" " " " 204294 with 200002E, 201522E and 204193
202305	12307	Feed Driving Rock Shaft Center (2)
200043E	12311	" " " " " " Set Screw (2)
204200	12305	Feed Driving Rock Shaft Crank with 204189 (on left side) and two 200383C
200383C	12311	Feed Driving Rock Shaft Crank Set Screw
213007	13104	Feed Lifting Cam with 202126
204202	12308	" " " " Fork with 200027E
200027E	12338	" " " " Pinch Screw
202126	12308	" " " " Position Pin
200045E	12338	" " " " Screw
203305	12334	" " " " Rock Shaft
203315	12334	" " " " 203305 with 203238
202305	12307	Feed Lifting Rock Shaft Center (2)
200043C	12311	" " " " " " Set Screw (2)
202276	12308	Feed Lifting Rock Shaft Slide Block
203238	12308	Feed Lifting Rock Shaft Slide Block 202276 with 200243E and 201531E

No.	Plate	Name
200243E	12338	Feed Lifting Rock Shaft Slide Block Hinge Screw
201531E	12308	Feed Lifting Rock Shaft Slide Block Hinge Screw Nut
204206	12306	Feed Regulating Handle
204207	12334	" " " " 204206 with 200098F, 202622, 204208 to 204210, 204213 and 204925
204208	12307	Feed Regulating Handle Adjustable Stop
200098F	12307	Feed Regulating Handle Adjustable Stop Screw
204925	12306	Feed Regulating Handle Adjustable Stop Screw Washer
204209	12307	Feed Regulating Handle Position Pin
204210	12306	Feed Regulating Handle Shaft
204211	12306	" " " " Crank with 200098F
204212	12307	Feed Regulating Handle Shaft Crank Link
200271E	12311	Feed Regulating Handle Shaft Crank Link Hinge Screw (lower)
200291E	12307	Feed Regulating Handle Shaft Crank Link Hinge Screw (upper)
200098F	12307	Feed Regulating Handle Shaft Crank Set Screw
204213	12307	Feed Regulating Handle Shaft Sleeve (split)
200362C	12311	Feed Regulating Handle Shaft Sleeve Set Screw
202622	12306	Feed Regulating Handle Shaft Sleeve Washer
202036	12338	Feed Regulating Handle Stop Pin
204214	-----	Feed Regulating Handle complete, Nos. 200291E, 204207, 204211 and 204212
*203482	-----	Hook (sewing)
203483	11249	" 203482 with 201253F, 201376F and 203251
203503	13104	Hook and Bobbin Case complete, Nos. 203483 and 203500
213810	11249	Hook Bevel Gear Socket, 24 teeth
200555H	11007	" " " " Screw ..
203242	11007	" " Pinion, 24 teeth, with two 200383C (2)
200383C	12311	Hook Bevel Pinion Set Screw
203306	12333	" Counter Shaft
203244	11007	" " " " Collar with two 200393C

No.	Plate	Name
200393c	11007	Hook Counter Shaft Collar Set Screw
203245	11007	Hook Counter Shaft Driving Gear, 44 teeth, with 200362c and 200439c
213157	---	Hook Counter Shaft Driving Gear 203245 with 200045e and 213007
200439c	12311	Hook Counter Shaft Driving Gear Position Screw
200362c	12311	Hook Counter Shaft Driving Gear Set Screw
203246	11007	Hook Counter Shaft Gear, 22 teeth, with two 200383c
200383c	12311	Hook Counter Shaft Gear Set Screw
202299	---	Hook Counter Shaft Oil Packing (wick)
200840E	11007	Hook Counter Shaft Oil Packing (wick) Stop Screw
213624	12333	Hook Driving Shaft
203248	12334	" " " Bearing with 202299
202299	---	Hook Driving Shaft Bearing Oil Packing (wick)
202126	12308	Hook Driving Shaft Bearing Position Pin
200516E	12311	Hook Driving Shaft Bearing Screw
203249	11007	" " " Bushing (eccentric)
202299	---	Hook Driving Shaft Bushing Oil Packing (wick)
200362c	12311	Hook Driving Shaft Bushing Set Screw
213141	13045	Hook Driving Shaft Collar with two 200393c
200393c	11007	Hook Driving Shaft Collar Set Screw
203251	13104	Hook Gib
201376F	13045	" " Hinge Screw
201253F	13045	" " Screw
203508	11249	" Saddle (left or right) with 200056D
200006E	11007	Hook Saddle Screw (4)
202622	12306	" " " Washer (4) ..
213018	---	" Washer
203507	11249	" " 213018 with 203476 and two 204243

No.	Plate	Name
203509	11249	Hook Saddle (left or right) complete, Nos. 200555H, 203478, 203499, 203503, 203506 to 203508 and 213810
203510	---	Hook Saddle Combination (left and right) complete, Nos. two 203509
202445	11125	Knee Lifter Connection Lever with 202446
227312	---	Knee Lifter Connection Lever 202445 with 200224H, 200262H, 227303 and 227308
200224H	12306	Knee Lifter Connection Lever Hinge Screw
227308	11125	Knee Lifter Connection Lever Lifting Rod with 202302
202302	12306	Knee Lifter Connection Lever Lifting Rod Cotter Pin
202446	12306	Knee Lifter Connection Lever Pin
227303	11125	Knee Lifter Lifting Lever
200262H	12306	" " " " Hinge Screw
231390	11886	Needle Bar (hollow)
204248	12307	" " Connecting Link
200658c	12307	" " " " Hinge Screw Stud
201519c	12307	Needle Bar Connecting Link Hinge Screw Stud Nut
204249	12308	Needle Bar Connecting Stud with 200072c and 202277
202277	---	Needle Bar Connecting Stud Oil Packing (wick)
200072c	12308	Needle Bar Connecting Stud Pinch Screw
204326	12338	Needle Bar Packing Cord (2)
200504E	13105	" " Screw Bushing (lower)
200503B	13105	" " " " (upper)
231381	13106	" Holder, needles $\frac{3}{32}$ in. apart and must be set diagonally, in gauges $\frac{1}{16}$, $\frac{1}{32}$, $\frac{3}{16}$ and $\frac{1}{8}$ in., with 201030F and two 200141F
201030F	13105	Needle Holder Screw
200141F	12225	" Set Screw
204252	12308	Presser Bar Lifter
200550c	12311	" " " Hinge Screw
204253	12308	" " Lifting Bracket with 200086c
200086c	12308	Presser Bar Lifting Bracket Pinch Screw

No.	Plate	Name
204254	12307	Presser Bar Lifting Bracket Position Guide
200362c	12311	Presser Bar Lifting Bracket Position Guide Set Screw
204327	12306	Presser Bar Packing Washer (felt)
200504F	13105	" " Screw Bushing (lower)
204258	13045	Presser Bar Spring (heavy)
200491B	12305	" " Thumb Screw (pressure regulating)
201906	—	Roller Presser, 1½ in. diam., ⅜ in. face (fine), with 200548F and 201534H
202839	—	Roller Presser Arm
204567	—	" " " 202839 with 201906
229341	11748	Roller Presser Arm Bracket (swing)
229344	—	Roller Presser Arm Bracket 229341 with 200096D, 201071F, 204567 and 229325
200675c	12225	Roller Presser Arm Bracket Position Screw Stud
202558	12225	Roller Presser Arm Bracket Spring
229370	—	" " " " " " Stop and Back Needle Guard Holder
229371	11748	Roller Presser Arm Bracket Spring Stop and Back Needle Guard Holder 229370 with 200159F, 200350H and 226220
200350H	11748	Roller Presser Arm Bracket Spring Stop and Back Needle Guard Holder Adjusting Screw
200096D	12225	Roller Presser Arm Screw
204495	12225	" " Bar
200548H	13045	" " Hinge Screw
201534H	12225	" " " " Nut
229328	11748	" " Needle Guard (back), in gauges ⅜, ⅝, ⅜ and ⅞ inch
200159F	11748	Roller Presser Needle Guard (back) Clamp Screw
226220	11748	Roller Presser Needle Guard (back) Clamp Screw Washer
229325	11748	Roller Presser Needle Guard (front), in gauges from ⅜ to ⅞ in., in steps of ⅜ inch
201071F	11748	Roller Presser Needle Guard (front) Screw

No.	Plate	Name
229345	13107	Roller Presser and Bar complete, in gauges ⅜, ⅝, ⅜ and ⅞ in., Nos. 200675c, 202558, 204495 229328, 229344, 229371 and two 200141F
213006	13045	Take-up Cam with 200335c, 200383c, 200430c, 200658c and 201519c
203172	12307	Take-up Cam Friction Washer
200430c	12311	" " Position Screw
200383c	12311	" " " " Check Screw
200335c	12311	Take-up Cam Set Screw
203311	13104	" Lever
221454	—	" " 203311 with 204263
204263	13104	" " Bearing with 204264
204264	12306	" " " Position Pin...
200042F	12311	" " " Screw
201816	12307	" " Roller
203312	13104	Take-up Lever complete, Nos. 200042F, 201816 and 221454
202402	12309	Tension Disc
202090	12309	" " Position Pin
204555	12338	" Release Lever
200309E	12309	" " " Screw
202075	12309	" " Plunger
215609	—	" " Slide
204268	13104	" " " 215609 with 204269
204269	13104	Tension Release Slide Spring
202407	10881	" Spring
200632B	12309	" Stud
200397H	12309	" " Set Screw
201572B	10881	" Thumb Nut
204271	12309	" Washer
204272	12309	Tension complete, Nos. 200632B, 201572B, 202075, 202407, 204271 and two 202402
204273	12308	Thread Controller Adjusting Collar with 200684H (for Presser Bar)
200684H	12308	Thread Controller Adjusting Collar Screw
204274	12309	Thread Controller Plate
200577H	12311	" " " Screw
202098	12309	" " Roller
204275	12309	" " " Guard
202084	12309	" " " Washer
200300C	12309	" " " Screw
204276	12309	" " Spring
204333	12309	" " " Guard
200581H	12309	" " " " Screw

No.	Plate	Name
204277	12309	Thread Controller Spring Stop
204278	12309	" " " " " Driv- ing Gear
200319c	12309	Thread Controller Spring Stop Driving Gear Hinge Screw
200135c	12309	Thread Controller Spring Stop Screw
204279	12309	Thread Controller Spring Stud with 204925
200366H	12309	Thread Controller Spring Stud Set Screw
204925	13105	Thread Controller Spring Stud Washer
205987	12309	Thread Controller complete. Nos. 200300c, 200581H, 202084, 202098, 204274, 204275 and 204333
204280	12309	Thread Controller and Spring com- plete, Nos. 204276 and 205987 ...
204556	13105	Thread Guide
203313	13105	" "
204329	—	" Oiler (felt)
204330	12225	" " Bracket with 204329
200113F	12225	" " " Screw
204281	12309	" Retainer Guide Wire
202091	12309	" " Sleeve
202092	12309	" " Spring
204058	12309	" " Stud
200368H	12309	" " " Set Screw
212178	12154	Throat Plate, 53 elongated needle hole, needles $\frac{3}{32}$ in. apart, for needle sizes 14 and 15, in gauges $\frac{1}{8}$, $\frac{3}{16}$ and $\frac{1}{4}$ in., for 212103
200161D	12319	Throat Plate Clamp Screw
202062	12308	" " Position Pin
200577H	12311	" " Screw

MACHINE No. 22w156

DROP FEED, ROLLER PRESSER

For Vamping, Foxing, Stitching Gloves, Etc.

In gauges from $\frac{3}{4}$ to $\frac{1}{8}$ inch.

The same as Machine No. 22w155 with the following
exceptions:

No.	Plate	Name
202781	11125	Foot Lifter Lifting Lever
227306	—	" " " " " 202781 with 200262H
227319	—	Foot Lifter Lifting Lever 227306 with 227318, in place of 227312
200262H	12306	Foot Lifter Lifting Lever Hinge Screw
227308	11125	Foot Lifter Lifting Lever Rod with 202302
227318	—	Foot Lifter Lifting Lever Rod 227308 with 206628, 227227 and 227576
204126	—	Foot Lifter Lifting Lever Rod Clamp with two 200530c
227316	12388	Foot Lifter Lifting Lever Rod Clamp Hook
227576	12388	Foot Lifter Lifting Lever Rod Clamp Hook 227316 with 204126
200530c	13105	Foot Lifter Lifting Lever Rod Clamp Set Screw
202302	12306	Foot Lifter Lifting Lever Rod Cotter Pin
206628	12388	Foot Lifter Lifting Lever Rod Spring
227227	12388	Foot Lifter Lifting Lever Rod Spring Collar with 200113F
200113F	12225	Foot Lifter Lifting Lever Rod Spring Collar Set Screw

ACCESSORIES

FOR MACHINE NO. 22w57

No.	Plate	Name
200157B	12338	Attachment Screw
203470	11249	Bobbin (10)
*225482	—	" Case Screw Driver Blade ...
*225483	—	" " " " Handle ..
225497	11156	Bobbin Case Screw Driver complete, Nos. 225482 and 225483 ...
225487	11748	Roller Presser Hinge Screw Nut Wrench
128 x 2	—	Needles, four each, sizes 11, 12 and 13
225191	—	Drip Pan with four wood screws $\frac{1}{2}$ in., No. 5
41400	13107	Machine Rest Pin (wood)
36578	11156	Oiler with 36579
36579	11156	" Spout, 3 $\frac{1}{2}$ in. long, with 120117
*225484	—	Screw Driver Blade
*225485	—	" " Handle
225498	11156	Screw Driver complete (7 $\frac{1}{4}$ in. long), Nos. 225484 and 225485 ...
225554	11156	Wrench (steel)

BOBBIN WINDER

Swing Automatic, Right Hand

*225451	—	Bobbin Winder Bobbin Holder ...
225453	10882	" " Frame with 202277 and 225438
225454	10882	Bobbin Winder Frame Hinge Pin
202277	—	" " " Oil Packing (wick)
225438	10882	Bobbin Winder Frame Oil Well Cap
225455	10882	" " " Spring
225456	10882	" " " Plunger
202473	10883	" " Pulley with 200105c
200105c	—	" " " Set Screw ...
*225443	—	" " Spindle
225452	10882	" " " 225443 with 225451
225444	10882	Bobbin Winder Stop Latch
200056E	10882	" " " " Screw..
225458	10882	" " " " Thumb Lever

No.	Plate	Name
225459	10882	Bobbin Winder Stop Latch Thumb Lever Hinge Stud
225460	10882	Bobbin Winder Stop Latch Thumb Lever Joint Stud
202478	10882	Bobbin Winder Stop Latch Trip Lever
200299II	10882	Bobbin Winder Stop Latch Trip Lever Hinge Screw
225461	10881	Bobbin Winder Tension Bracket with 201499B
200082D	10881	Bobbin Winder Tension Bracket Screw
202104	10881	Bobbin Winder Tension Bracket Screw Washer
2102	10881	Bobbin Winder Tension Disc
202407	10881	" " " Spring
201499B	10881	" " " Stud
201572B	10881	" " " " Thumb Nut
225462	10881	Bobbin Winder Tension Bracket complete, Nos. 201572B, 202407, 225461 and two 2102
225433	10883	Bobbin Winder and Tension Bracket Base
225436	10883	Universal Bobbin Winder complete, Nos. 200056E, 200082D, 200299II, 202104, 202473, 202478, 225433, 225444, 225452 to 225456, 225458 to 225460, 225462 and two wood screws $\frac{3}{4}$ in., No. 13, R.H.B.

KNEE LIFTER PARTS

227781	11125	Knee Lifter Rock Lever with 200522c and 200529c
227782	—	Knee Lifter Rock Lever 227781 with two each 202451 and 202452
227783	11125	Knee Lifter Rock Lever 227782 with 202985 and 227784
202453	11125	Knee Lifter Rock Lever Knee Plate with 200526c
202985	—	Knee Lifter Rock Lever Knee Plate 202453 with 205455
202455	11125	Knee Lifter Rock Lever Knee Plate Arm (short)
200522c	12319	Knee Lifter Rock Lever Knee Plate Arm Set Screw
200526c	12319	Knee Lifter Rock Lever Knee Plate Set Screw

No.	Plate	Name
202451	11125	Knee Lifter Rock Lever Lug with two wood screws $\frac{3}{4}$ in., No. 13H
202452	12319	Knee Lifter Rock Lever Lug Hinge Pin
227784	11125	Knee Lifter Rock Lever Rod, 3 in. long, with 227785
*227785	—	Knee Lifter Rock Lever Rod Cap or Oil Guard
200529c	12319	Knee Lifter Rock Lever Rod Set Screw

(Other Knee Lifter parts are listed with parts of machine head).

THREAD UNWINDER

202486	—	Spool Pin
202487	—	" Rest
227498	—	" "
202488	10838	" " 202487 with 200363c, 200383c and two 202486
227499	10838	Spool Rest 227498 with 200363c and 202486
202489	10838	Spool Rest Rod
200383c	12311	" " " Set Screw
200383c	12311	" " " Set Screw
202490	10838	" Stand with 200383c
202491	—	" Washer (steel)
202492	—	" Weight with 202493
202493	—	" " Center with 202793 and 203163
203163	—	Spool Weight Center Bushing
202793	—	" " Thread Guide
202794	10838	Thread Eyelet Rod
227605	10838	" " "
227606	10838	" " " Clamp with two 200396c
200396c	13105	Thread Eyelet Rod Clamp Set Screw
200363c	12338	Thread Eyelet Rod Set Screw
227500	10838	Thread Unwinder complete, Nos. 202488 to 202490, 202794, 227499, 227605, 227606, three each 202491, 202492 and wood screws $\frac{3}{4}$ in., No. 13

FOR MACHINE NO. 22w58

Same as for No. 22w57 with the following exceptions:

FOOT LIFTER

No.	Plate	Name
227952	11156	Foot Lifter Lever (left or right) with 227954
227678	11156	Foot Lifter Lever Chain, 48 in. long, with 202784
227954	—	Foot Lifter Lever Chain Hook (lower)
202784	12388	Foot Lifter Lever Chain Hook (upper)
225016	12388	Foot Lifter Lever Hinge Pin
227953	11156	" " " Stand with two wood screws 1 in., No. 13
227955	11156	Foot Lifter Lever (left or right) complete, Nos. 225016, 227678, 227952 and 227953, in place of 227783

FOR MACHINE NO. 22w155

Same as for No. 22w57 with the following exceptions:

225181	—	Drip Pan with four wood screws $\frac{1}{2}$ in., No. 5, in place of 225191
--------	---	---

KNEE LIFTER

227781	11125	Knee Lifter Rock Lever with 200522c and 200529c
227782	—	Knee Lifter Rock Lever 227781 with two each 202451 and 202452
227787	—	Knee Lifter Rock Lever 227782 with 202203 and 227784, in place of 227783
202453	11125	Knee Lifter Rock Lever Knee Plate with 200526c
202203	—	Knee Lifter Rock Lever Knee Plate 202453 with 202454
202454	11125	Knee Lifter Rock Lever Knee Plate Arm (long)
200522c	12319	Knee Lifter Rock Lever Knee Plate Arm Set Screw
200526c	12319	Knee Lifter Rock Lever Knee Plate Set Screw

No.	Plate	Name
202451	11125	Knee Lifter Rock Lever Lug with two wood screws $\frac{3}{4}$ in., No. 13u
202452	12319	Knee Lifter Rock Lever Lug Hinge Pin
227784	11125	Knee Lifter Rock Lever Rod, 3 in. long, with 227785
*227785	—	Knee Lifter Rock Lever Rod Cap or Oil Guard
200529c	12319	Knee Lifter Rock Lever Rod Set Screw

FOR MACHINE NO. 22w156

Same as for No. 22w155 with the following exceptions:

FOOT LIFTER

227952	11156	Foot Lifter Lever (left or right) with 227954
227678	11156	Foot Lifter Lever Chain, 48 in. long, with 202784
227954	—	Foot Lifter Lever Chain Hook (lower)
202784	12388	Foot Lifter Lever Chain Hook (upper)
225016	11156	Foot Lifter Lever Hinge Pin
227953	11156	" " " Stand with two wood screws 1 in., No. 13
227955	11156	Foot Lifter Lever (left or right) complete, Nos. 225016, 227678, 227952 and 227953, in place of 227783

FEED DOGS

No.	Plate	Name
212100	13106	Feed Dog, for 212176 to 212179 ...
212103	13106	" " " 212176 to 212179 ...
212104	13106	" " " 212176 to 212179 ...
211650	13106	" " " 212180 and 212200 ...

ROLLER PRESSERS

201906	—	Roller Presser, 1 $\frac{1}{4}$ in. diam., $\frac{1}{16}$ in. face (fine), with 200548F and 201534H
201907	13106	Roller Presser, 1 $\frac{1}{4}$ in. diam., $\frac{5}{32}$ in. face (fine), with 200548F and 201534H
201908	11748	Roller Presser, 1 $\frac{1}{4}$ in. diam., $\frac{1}{8}$ in. face (fine), with 200548F and 201534H
201909	11748	Roller Presser, $\frac{13}{16}$ in. diam., $\frac{3}{8}$ in. face (coarse), with 200551F and 201534H
201910	12225	Roller Presser, $\frac{13}{16}$ in. diam., $\frac{1}{4}$ in. face (coarse), with 200551F and 201534H
201911	11748	Roller Presser, 1 in. diam., $\frac{1}{4}$ in. face (coarse), with 200551F and 201534H
202839	—	Roller Presser Arm
204328	—	" " "
204567	—	" " " 202839 with 201906
204570	12225	Roller Presser Arm 204328 with 201910
229341	11748	Roller Presser Arm Bracket (swing)
229344	—	" " " " 229341 with 200096D, 201071F, 204567 and 229325

No.	Plate	Name
229747	—	Roller Presser Arm Bracket 229341 with 200096b, 201071F, 204567 and 229326
200675c	12225	Roller Presser Arm Bracket Position Screw Stud
202558	12225	Roller Presser Arm Bracket Spring
202559	12225	" " " " " " Stop
200141F	12225	Roller Presser Arm Bracket Spring Stop Screw
229370	—	Roller Presser Arm Bracket Spring Stop and Back Needle Guard Holder
229371	11748	Roller Presser Arm Bracket Spring Stop and Back Needle Guard Holder 229370 with 200159F, 200350H and 226220
200350H	11748	Roller Presser Arm Bracket Spring Stop and Back Needle Guard Holder Adjusting Screw
200141F	12225	Roller Presser Arm Bracket Spring Stop and Back Needle Guard Holder Set Screw
200096b	12225	Roller Presser Arm Screw
204495	12225	" " Bar
200548F	13045	" " Hinge Screw
200551H	12225	" " " " " "
201534H	12225	" " " " Nut
229328	11748	" " Needle Guard (back), in gauges $\frac{1}{16}$, $\frac{1}{8}$, $\frac{3}{16}$ and $\frac{1}{4}$ inch
229329	13106	Roller Presser Needle Guard (back), in $\frac{1}{8}$ in. gauge
200159F	11748	Roller Presser Needle Guard (back) Clamp Screw
226220	11748	Roller Presser Needle Guard (back) Clamp Screw Washer
200134c	13105	Roller Presser Needle Guard (back) Screw
213699	13106	Roller Presser Needle Guard (back) Spring Guide
229339	13106	Roller Presser Needle Guard (back) Spring Guide
200175c	12308	Roller Presser Needle Guard (back) Spring Guide Screw
229325	11748	Roller Presser Needle Guard (front), in gauges from $\frac{1}{16}$ to $\frac{3}{16}$ in., in steps of $\frac{1}{16}$ inch
229326	—	Roller Presser Needle Guard (front), in gauges from $\frac{1}{16}$ to $\frac{3}{16}$ in., in steps of $\frac{1}{16}$ inch

No.	Plate	Name
201071F	11748	Roller Presser Needle Guard (front) Screw
229345	13107	Roller Presser and Bar complete, in gauges $\frac{1}{16}$, $\frac{1}{8}$, $\frac{3}{16}$ and $\frac{1}{4}$ in., Nos. 200675c, 202558, 204495, 229328, 229344, 229371 and two 200141F
229748	13107	Roller Presser and Bar complete, in gauges $\frac{1}{16}$, $\frac{1}{8}$, $\frac{3}{16}$ and $\frac{1}{4}$ in., Nos. 200675c, 202558, 202559, 204495, 229747 and two 200141F

THROAT PLATES

212176	12154	Throat Plate, 53 needle hole, needles $\frac{1}{16}$ in. apart, for needle sizes 12 and 13, in gauges $\frac{1}{16}$, $\frac{1}{8}$ and $\frac{1}{4}$ in., for 212100, 212103 and 212104
212177	12154	Throat Plate, 50 needle hole, needles $\frac{1}{16}$ in. apart, for needle sizes 14 and 15, in gauges $\frac{1}{16}$, $\frac{1}{8}$ and $\frac{1}{4}$ in., for 212100, 212103 and 212104
212178	12154	Throat Plate, 53 elongated needle hole, needles $\frac{1}{16}$ in. apart, for needle sizes 14 and 15, in gauges $\frac{1}{16}$, $\frac{1}{8}$ and $\frac{1}{4}$ in., for 212100, 212103 and 212104
212179	12154	Throat Plate, 50 elongated needle hole, needles $\frac{1}{16}$ in. apart, for needle sizes 16 and 18, in gauges $\frac{1}{16}$, $\frac{1}{8}$ and $\frac{1}{4}$ in., for 212100, 212103 and 212104
212180	12154	Throat Plate, 50 needle hole, needles $\frac{1}{16}$ in. apart, for needle sizes 14 and 15, in gauges $\frac{1}{16}$, $\frac{1}{8}$ and $\frac{1}{4}$ in., for 211650
212200	12154	Throat Plate, 53 needle hole, needles $\frac{1}{16}$ in. apart, for needle sizes 12 and 13, in gauges $\frac{1}{16}$, $\frac{1}{8}$ and $\frac{1}{4}$ in., for 211650

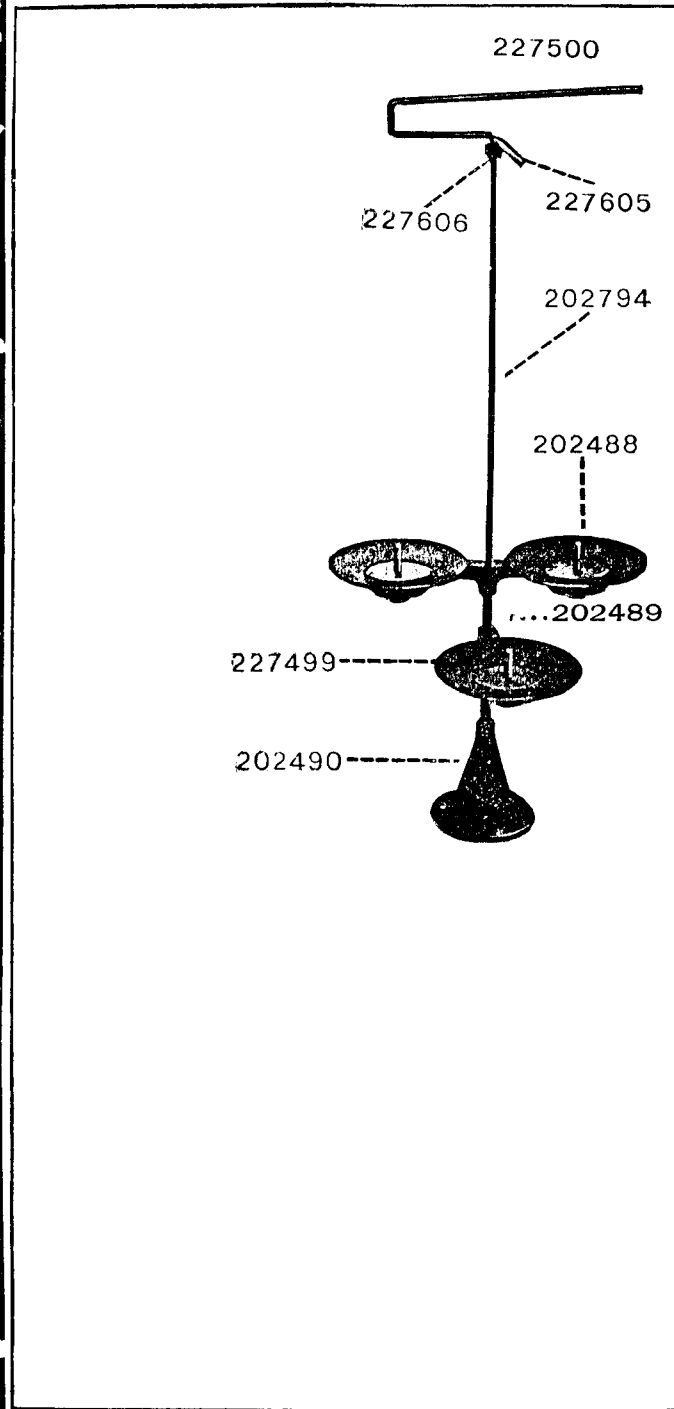
OBSOLETE PARTS

No.	Plate	Name
202470	12320	Bobbin Winder Base
202471	12320	" " Frame
202472	12319	" " " Spring
202474	12320	" " Spindle
227522	12319	" " Stop Latch
202477	12319	" " " " Thumb Lever
227523	12320	Bobbin Winder complete, Nos. 200056E, 200161D, 200221D, 201537H, 202470 to 202474, 202477, 202478, 227522, three 200299H and two round head wood screws 1 in., No. 13
202480	12320	Bobbin Winder Spool Holder Base with 200355H and 202484
202481	12320	Bobbin Winder Spool Holder Base Spool Pin
202482	12319	Bobbin Winder Spool Holder Ten- sion Disc (lower or upper)
202483	12319	Bobbin Winder Spool Holder Ten- sion Disc Spring (brass)
202484	12319	Bobbin Winder Spool Holder Ten- sion Disc Thread Guide
202485	12320	Bobbin Winder Spool Holder com- plete, Nos. 200011E, 202480, 202481, 202483, two 202482 and one wood screw 1 in., No. 13H
*213605	—	Feed Driving Cam Fork Lever Slide Block
*213604	—	Feed Driving Cam Fork Lever Slide Block with 200116C
213606	13104	Feed Driving Cam Fork Lever Slide Block 213604 with 213605
203250	11007	Hook Driving Shaft Collar with two 200393C
204870	12333	Needle Bar (hollow)
203701	13106	" Holder, needles $\frac{3}{8}$ in. apart and must be set diagonally, in gauges $\frac{1}{16}$, $\frac{1}{8}$, $\frac{3}{16}$ and $\frac{1}{4}$ in., with 200068H and two 200141E

NUMERICAL LIST OF PARTS

No.	Plate	Name
2102	10881	Bobbin Winder Tension Disc, for 225462
36578	11156	Oiler with 36579
36579	11156	" Spout, $3\frac{1}{2}$ in. long, with 120117, for 36578
41400	13107	Machine Rest Pin (wood)
120117	—	Oiler Spout Washer, for 36579
200002E	12338	Feed Driving Cam Fork Lever Con- nection Hinge Screw, for 206554 and 206555
200006E	11007	Hook Saddle Screw
200011E	12319	Bobbin Winder Spool Holder Ten- sion Disc Screw, for 202485
200027E	12338	Feed Lifting Cam Fork Pinch Screw, for 204202
200031E	12311	Feed Driving Cam Fork Lever Con- nection Clamp Pinch Screw, for 204194
200042E	12311	Take-up Lever Bearing Screw, for 203312
200043C	12311	Feed Driving Cam Fork Lever Shaft Sleeve Set Screw
200043C	12311	Feed Driving Rock Shaft Center Set Screw
200043C	12311	Feed Lifting Rock Shaft Center Set Screw
200045E	12338	Feed Lifting Cam Screw, for 213157
200053C	12311	Face Plate Screw
200054E	12307	Arm Shaft Connection Screw, for 204440
200056D	10882	Bobbin Case Lever Fulcrum Screw, for 203508
200056E	10882	Bobbin Winder Stop Latch Screw, for 225436 and 227523
200062H	12311	Balance Wheel Adjusting Screw
200068H	13105	Needle Holder Screw, for 203701 ..
200072C	12308	" Bar Connecting Stud Pinch Screw, for 204249
200075E	13105	Feed Dog Support Screw
200082D	10881	Bobbin Winder Tension Bracket Screw, for 225436
200086C	12308	Presser Bar Lifting Bracket Pinch Screw, for 204253

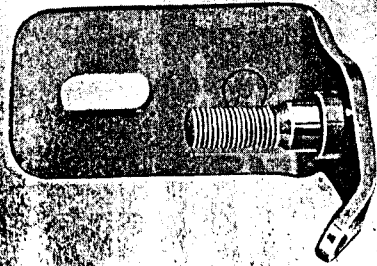
PLATE 10838—ONE-EIGHTH SIZE



From the library of: Diamond Needle Corp

PLATE 10881—FULL SIZE

225461



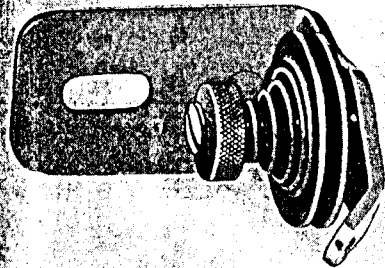
200082 202104



2102



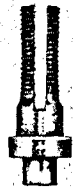
225462



202407



201499

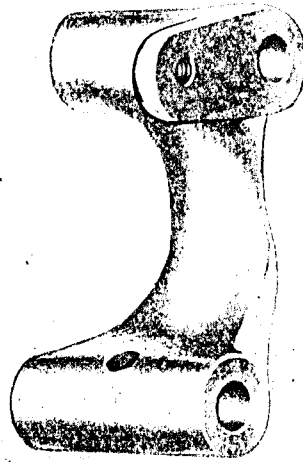


201572



PLATE 10882—FULL SIZE

225453



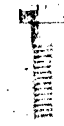
225455 225438



200380



200056



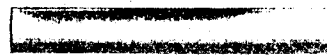
225456



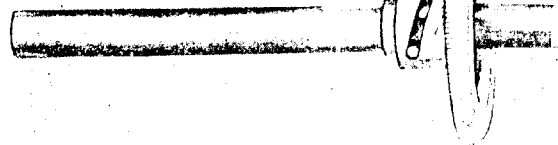
200299



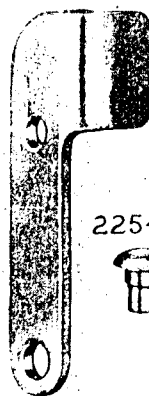
225454



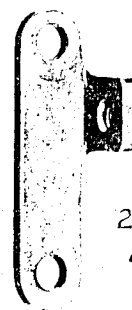
225452



225458



202478



225444



225459

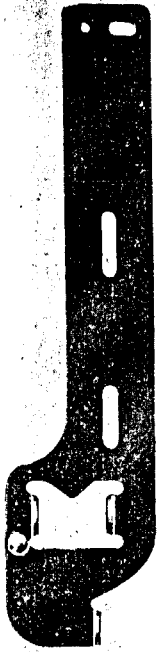


225460

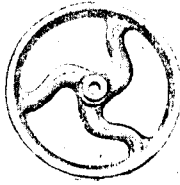


PLATE 10883 ONE-FOURTH SIZE

225433



202473



225436

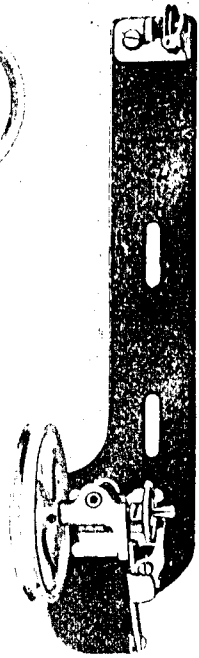


PLATE 11007-FULL SIZE

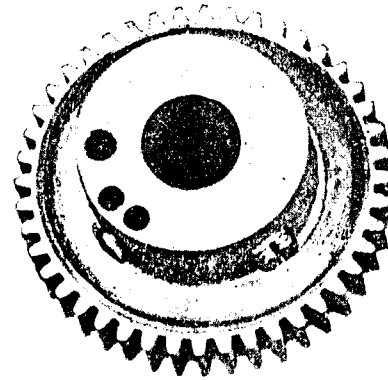
200555



203242



203245



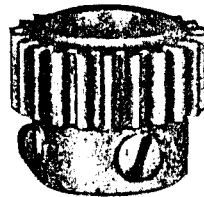
203250



200393



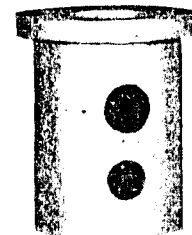
203246



200006



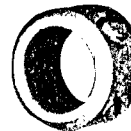
203249



225585



203244



200840



PLATE 11125 - ONE-FOURTH SIZE

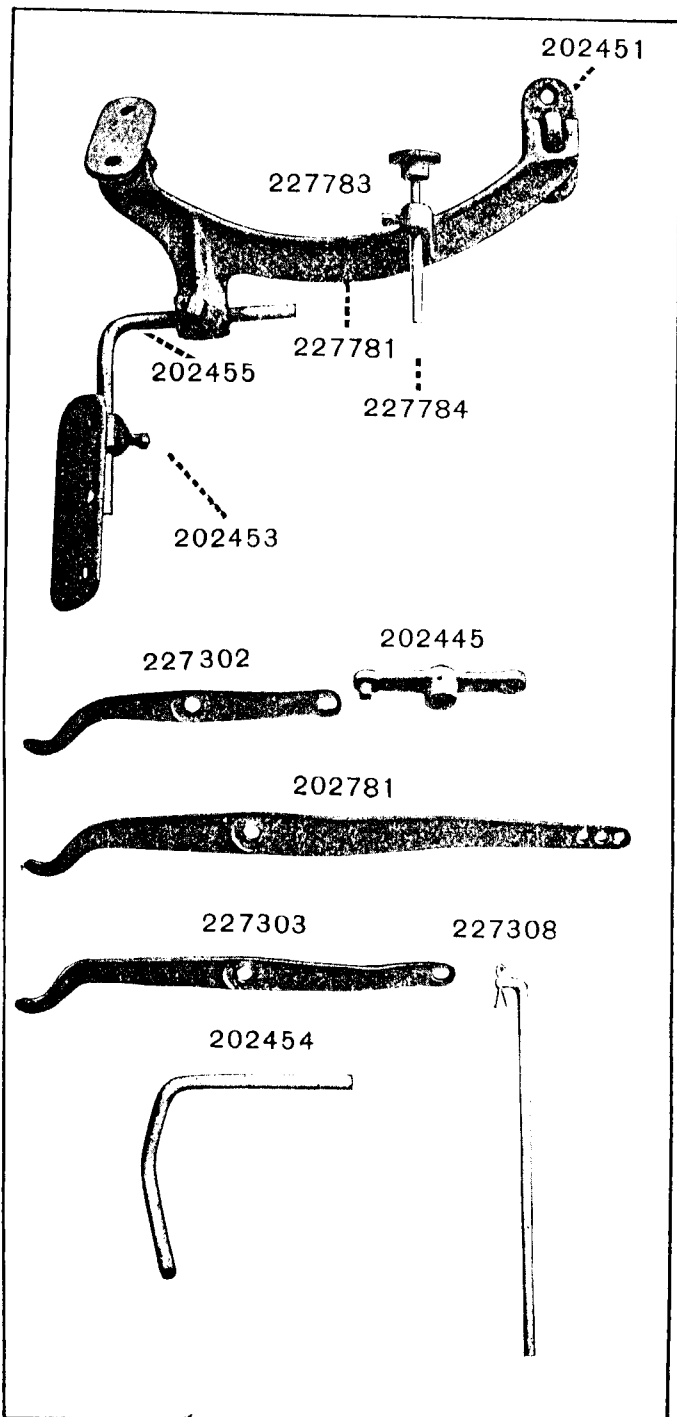


PLATE 11156 - ONE-FOURTH SIZE

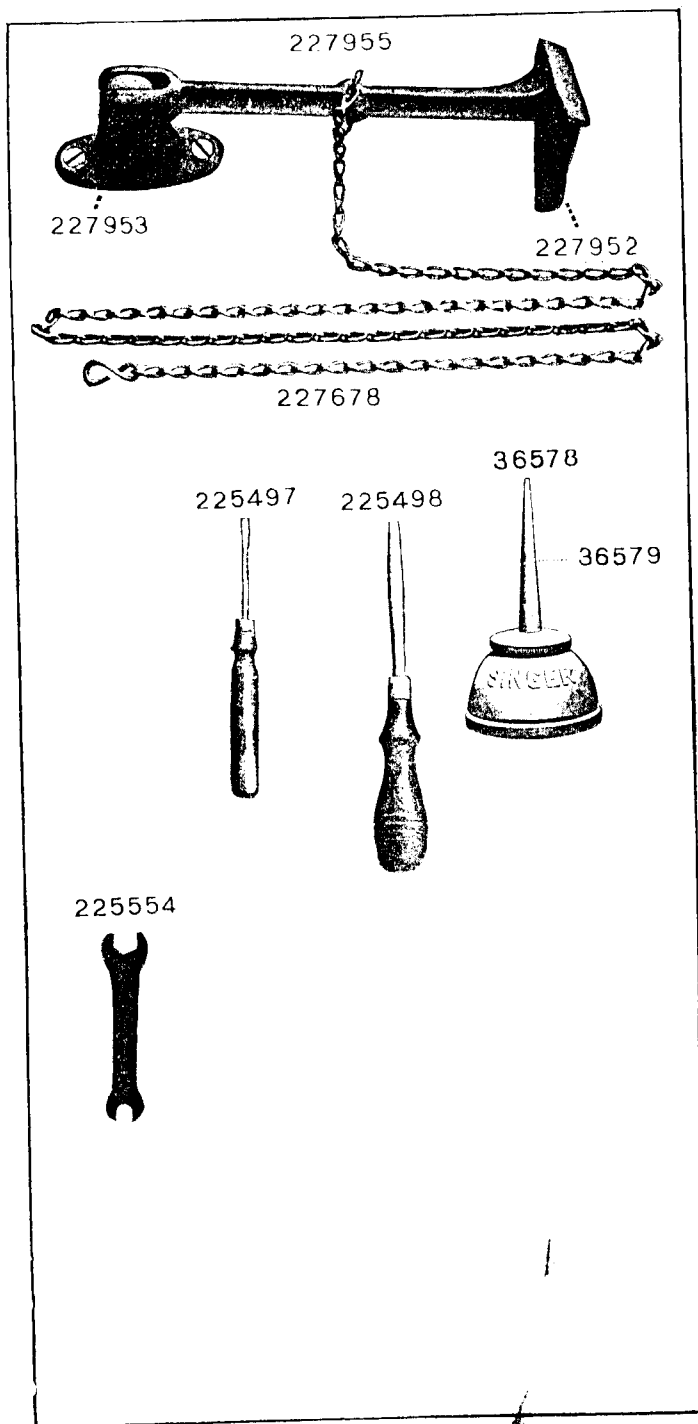


PLATE 11249—ONE-HALF SIZE

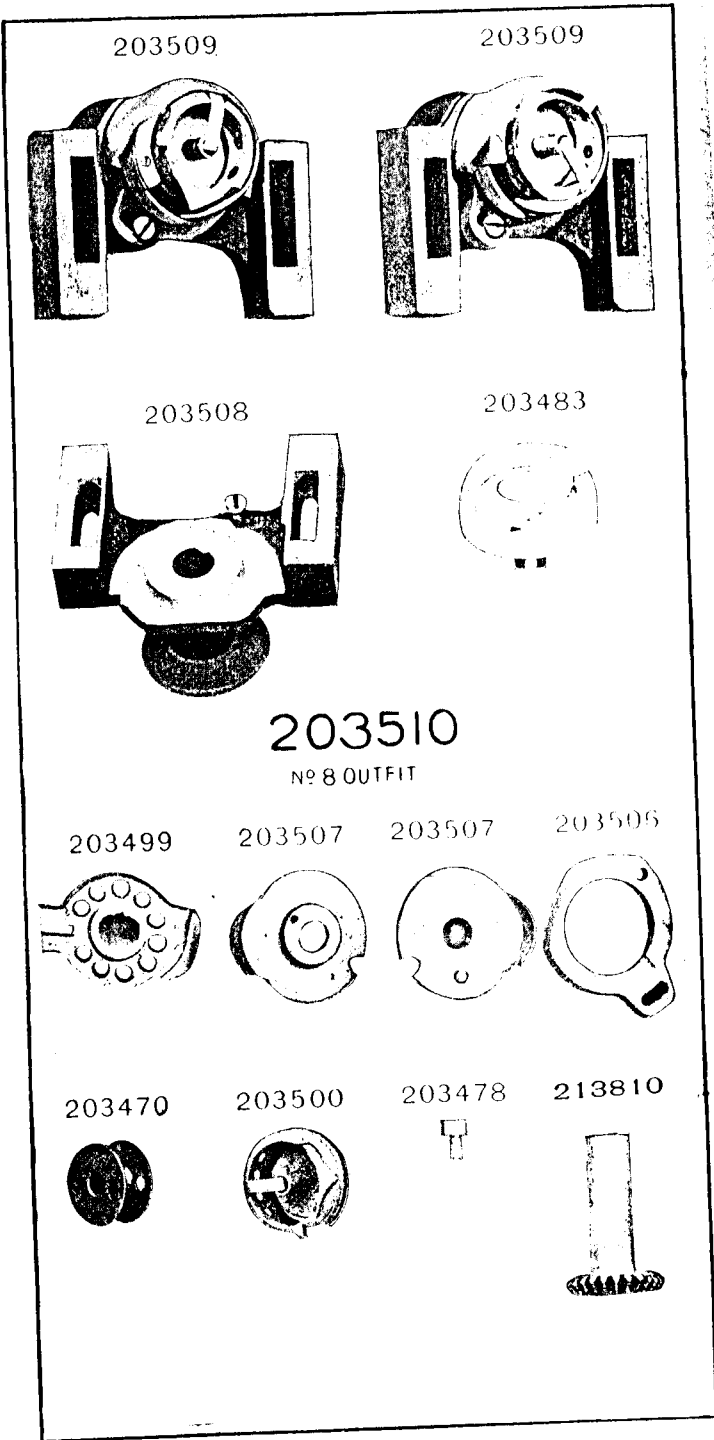
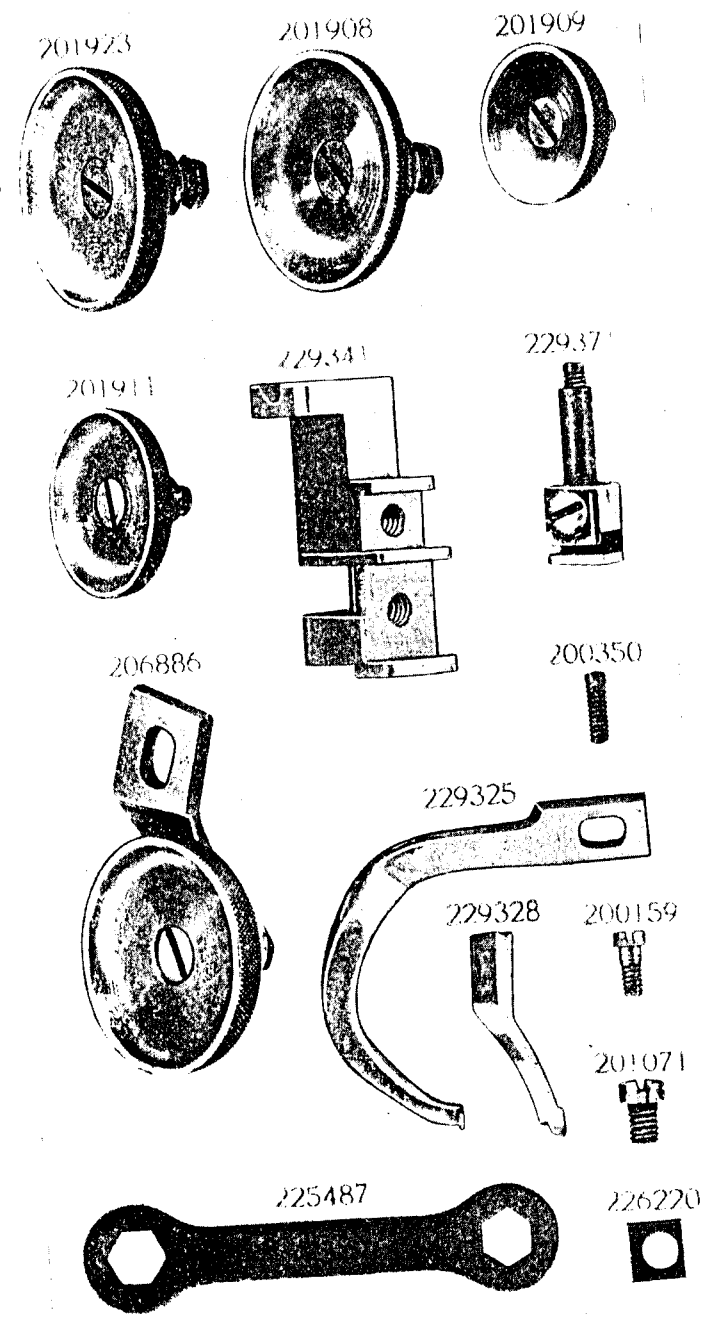


PLATE 11748—FULL SIZE



From the library of: Diamond Needle Corp

PLATE 11886—ONE-HALF SIZE

231390



203329

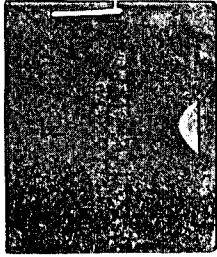


PLATE 12154—FULL SIZE

212176
212177
212178
212179



212176
212177
212178
212179



212180
212200



212180
212200

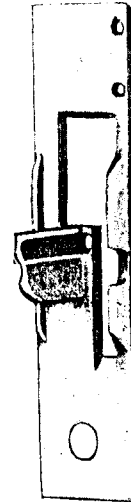


PLATE 12225—FULL SIZE

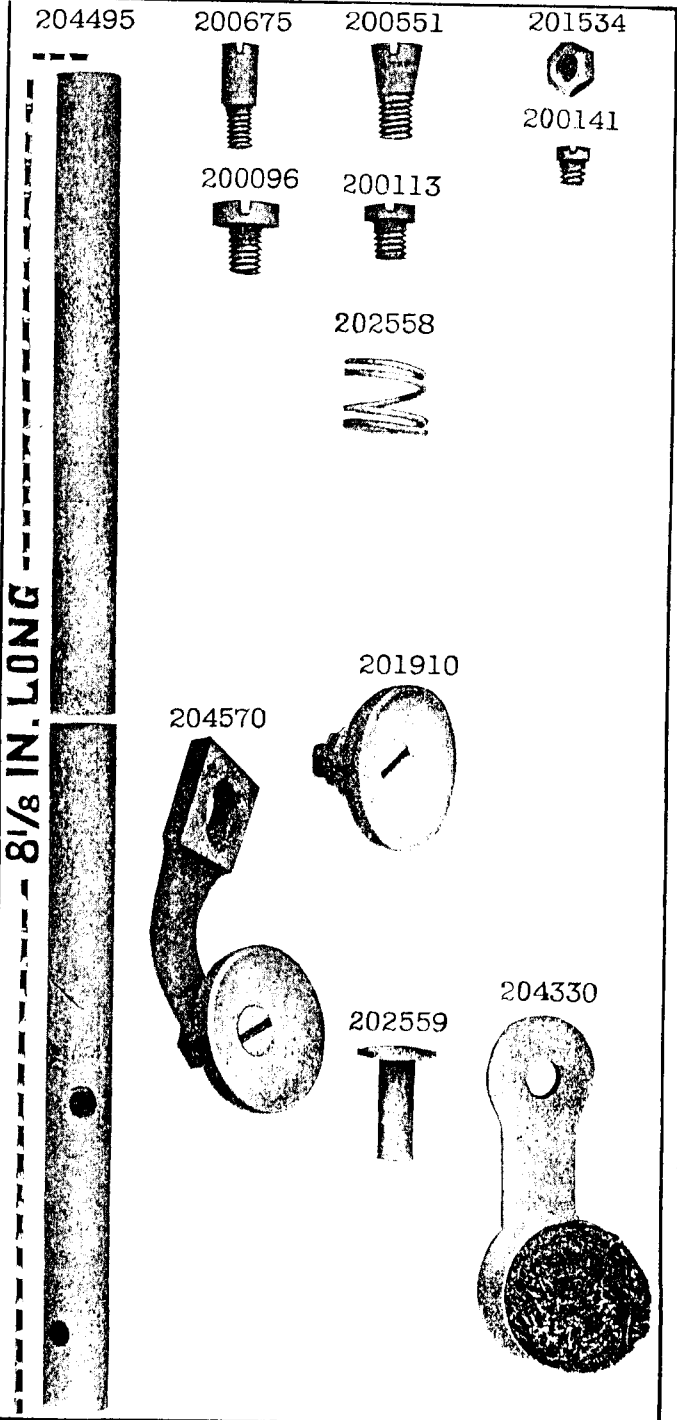
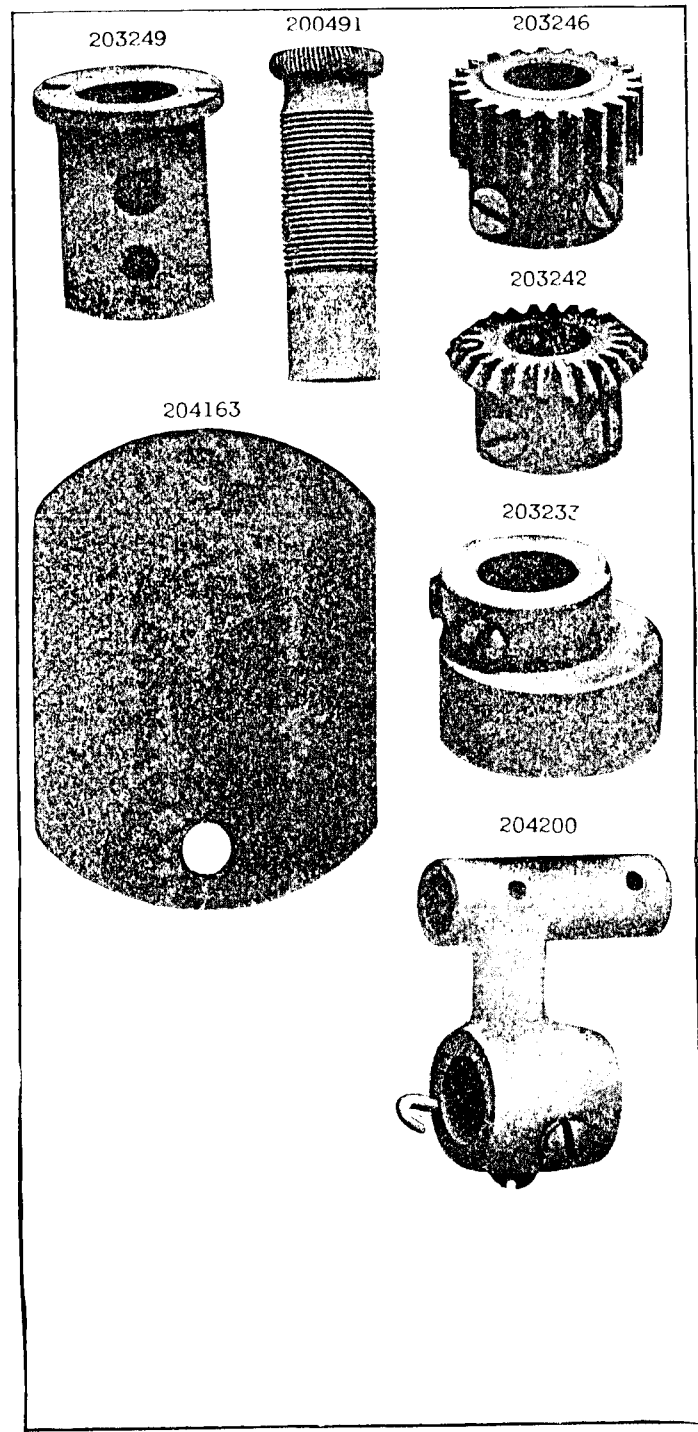


PLATE 12305—FULL SIZE



From the library of: Diamond Needle Corp

PLATE 12306—FULL SIZE

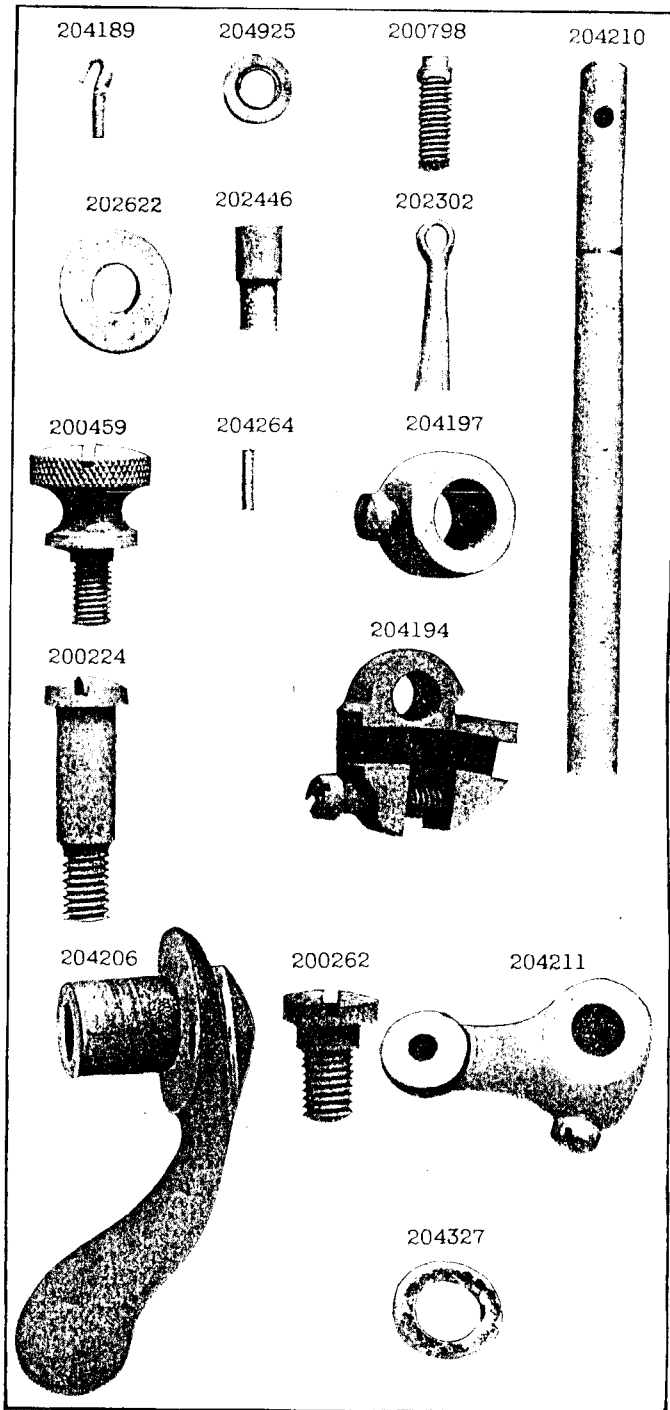
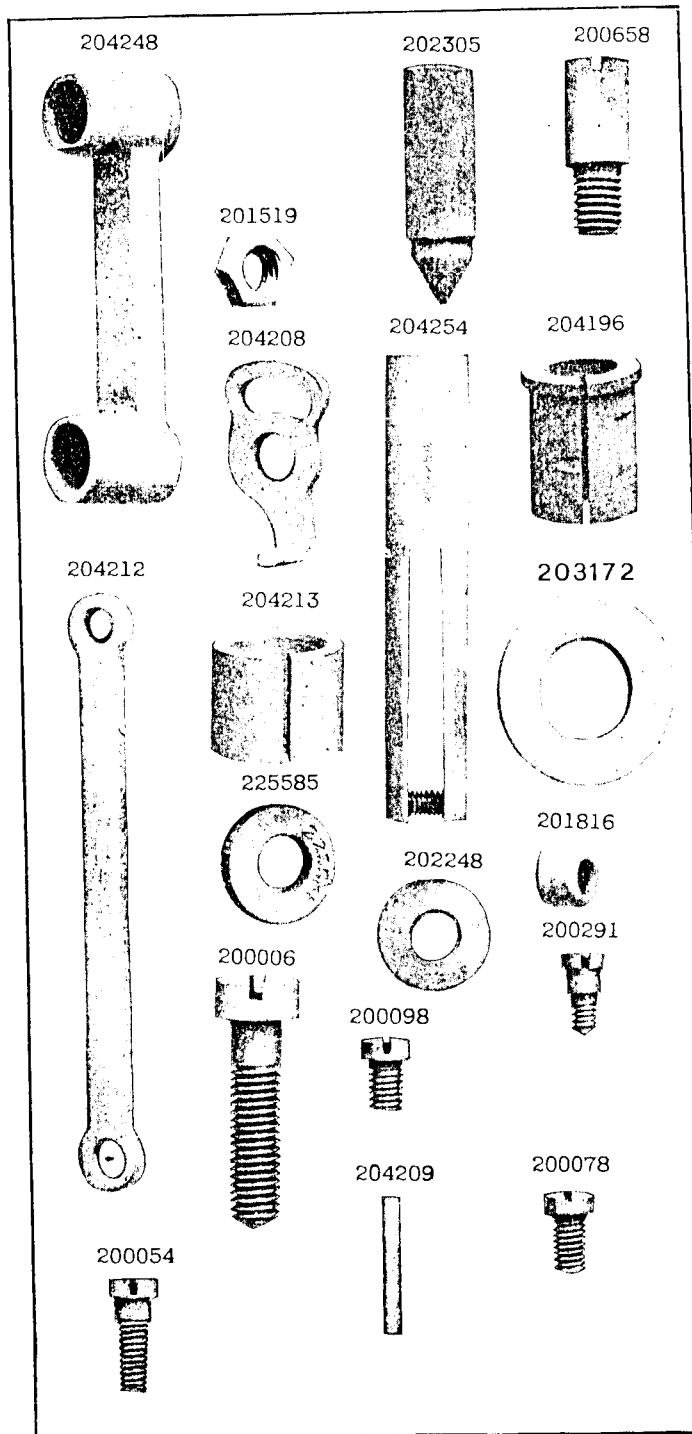


PLATE 12307—FULL SIZE



From the library of: Diamond Needle Corp

PLATE 12308—FULL SIZE

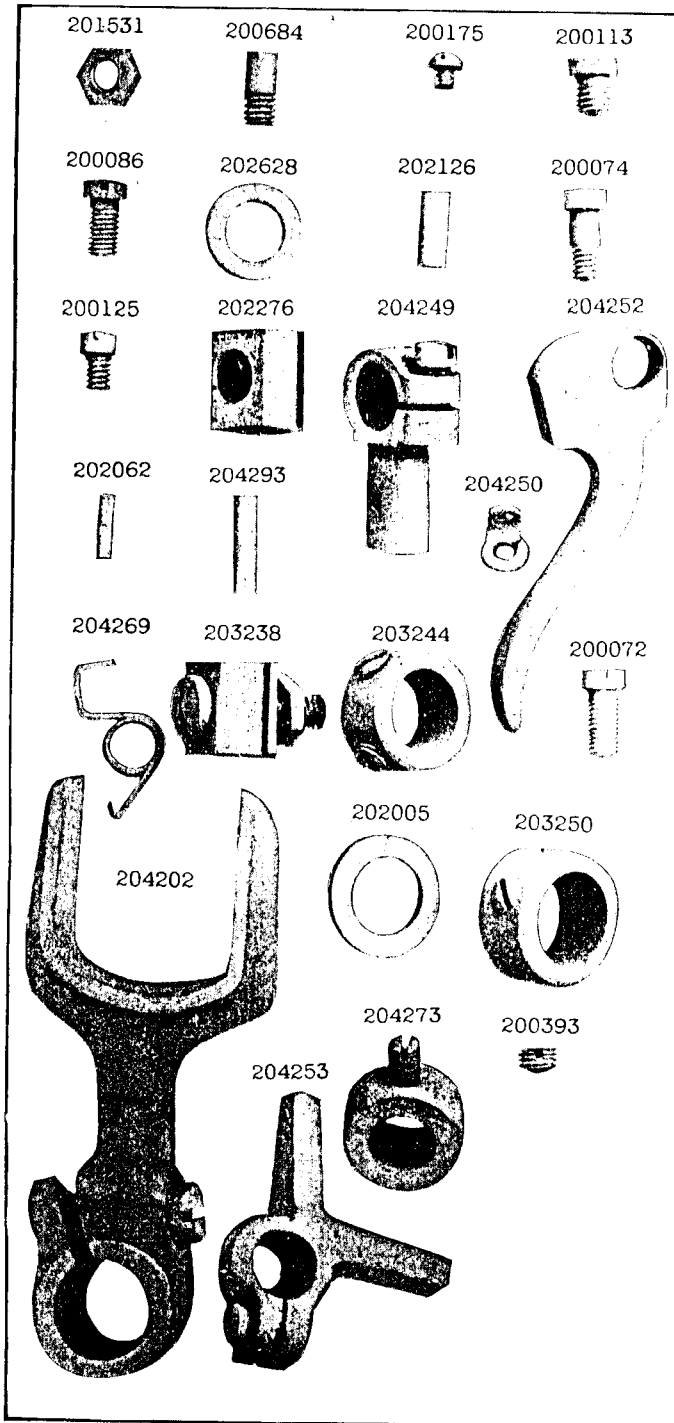
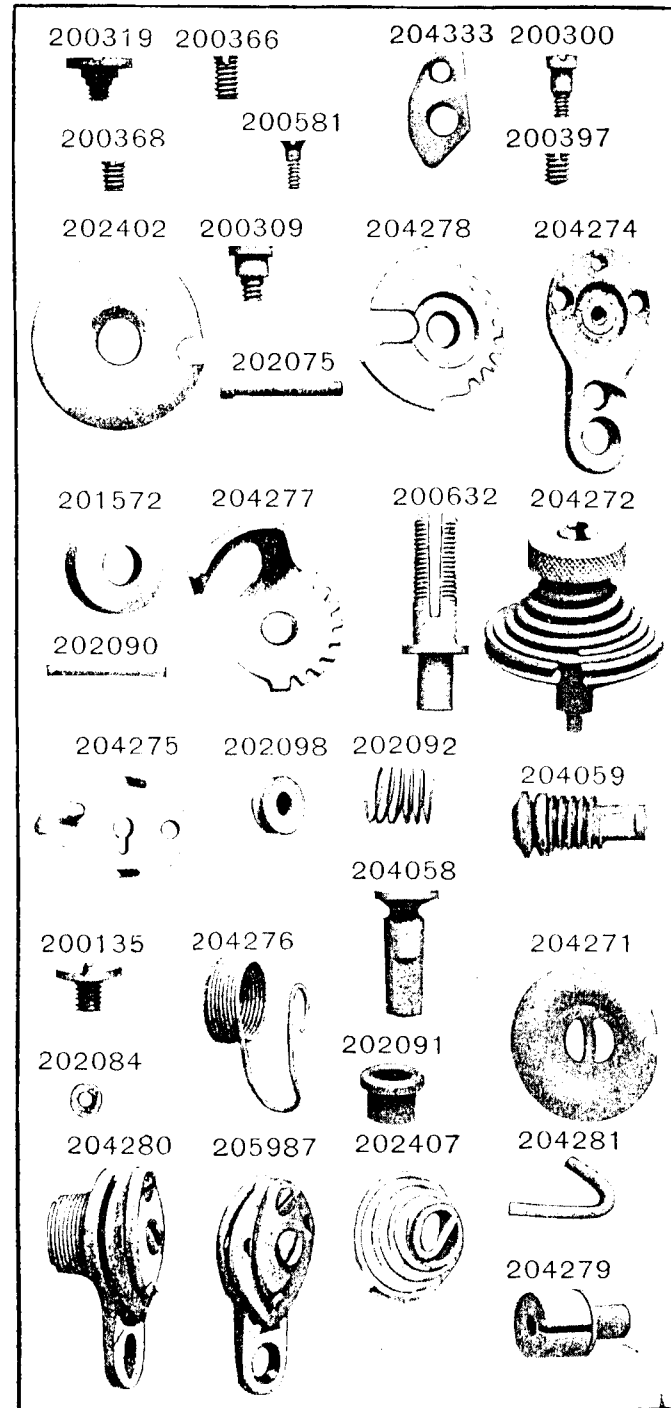


PLATE 12309—FULL SIZE



From the library of: Diamond Needle Corp

PLATE 12311-FULL SIZE

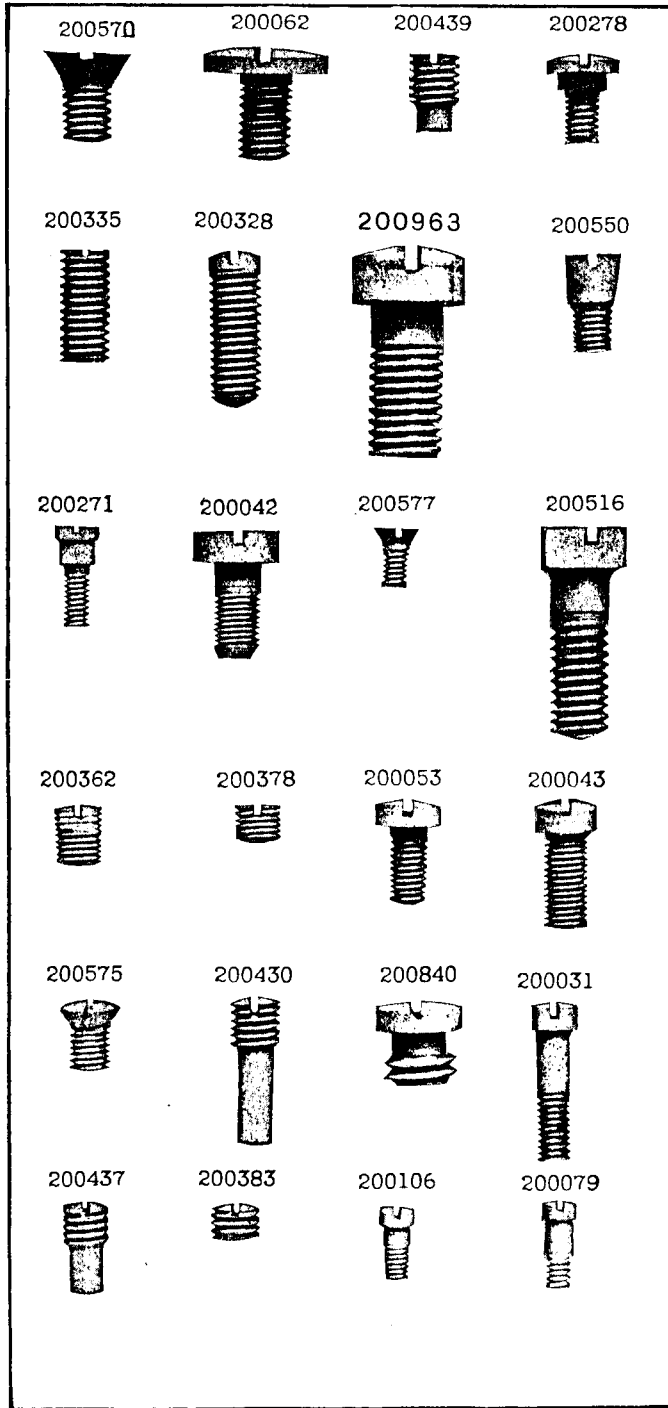


PLATE 12319-FULL SIZE

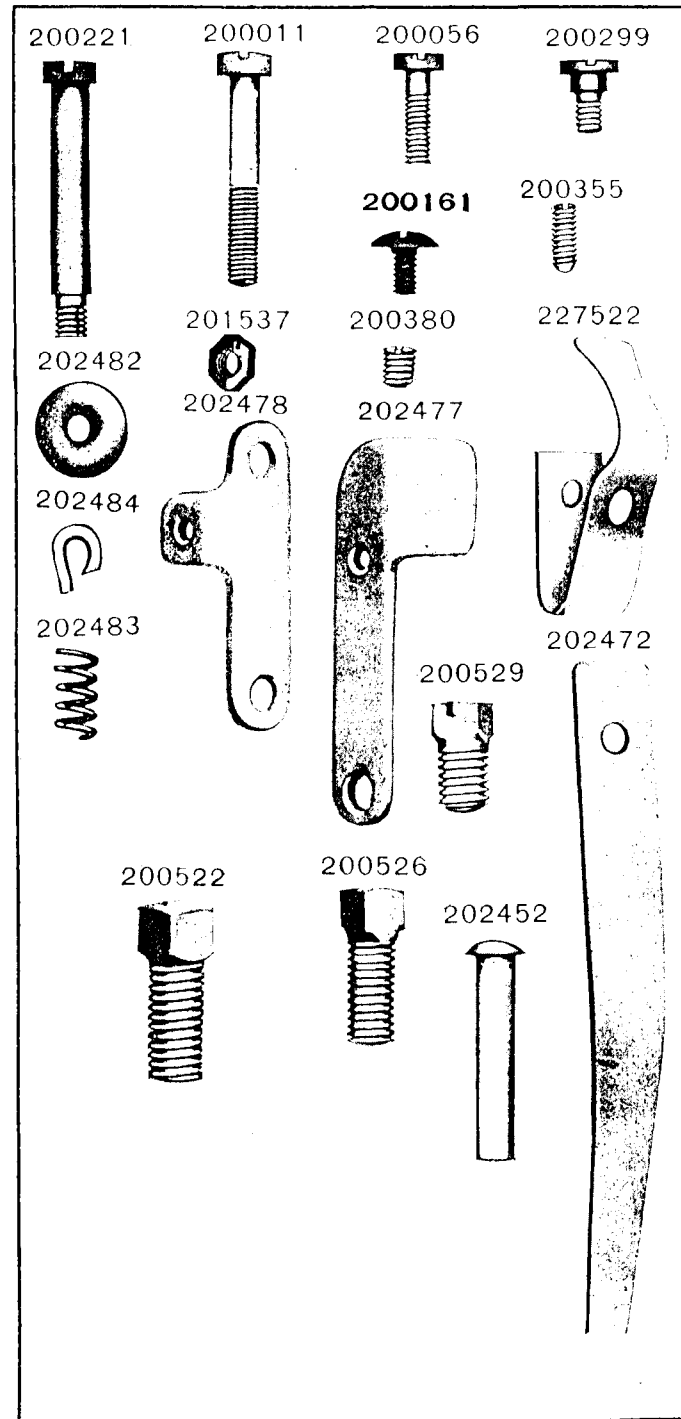


PLATE 12320—ONE-HALF SIZE

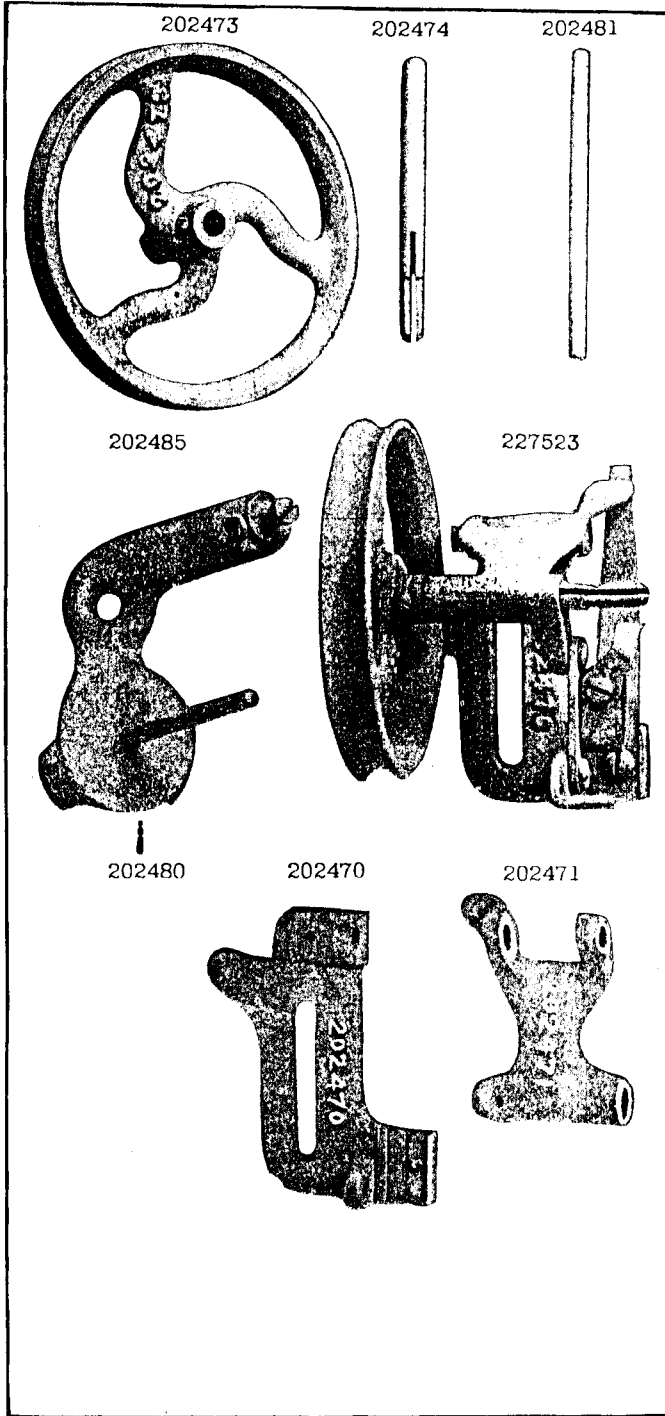


PLATE 12333—ONE-FOURTH SIZE

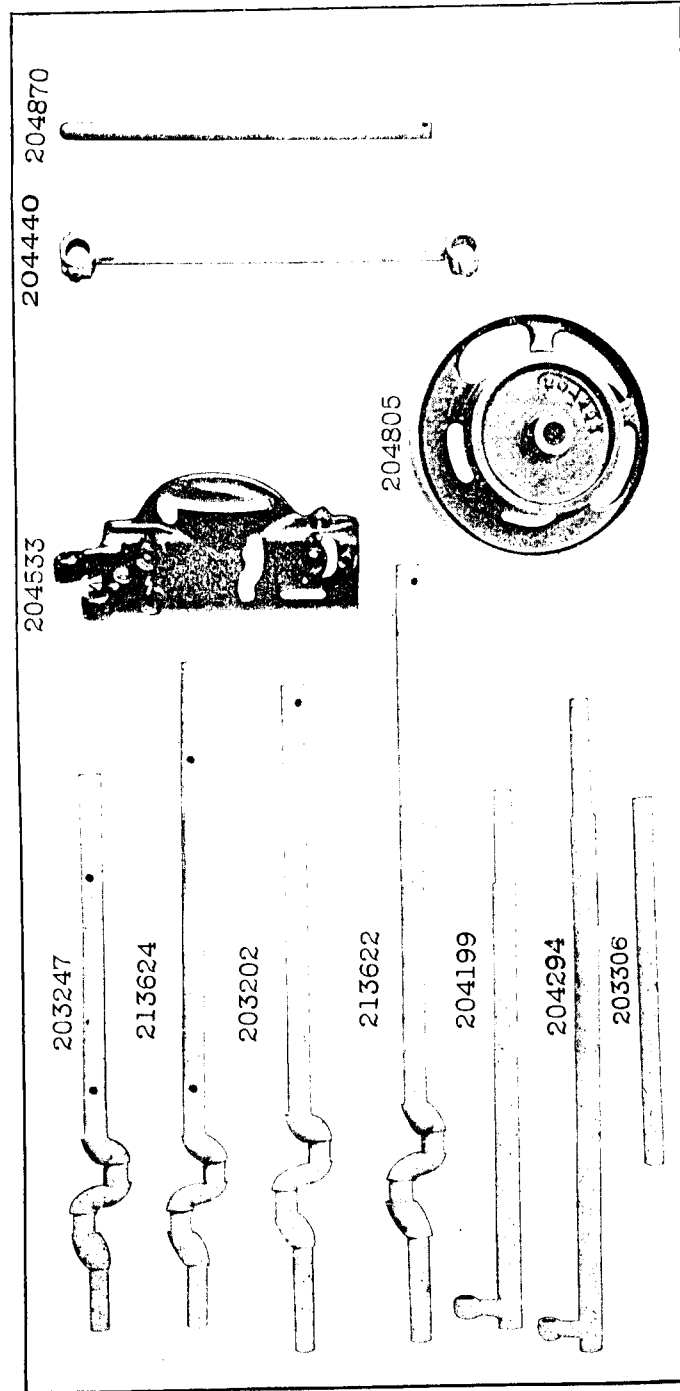


PLATE 12334—ONE-HALF SIZE

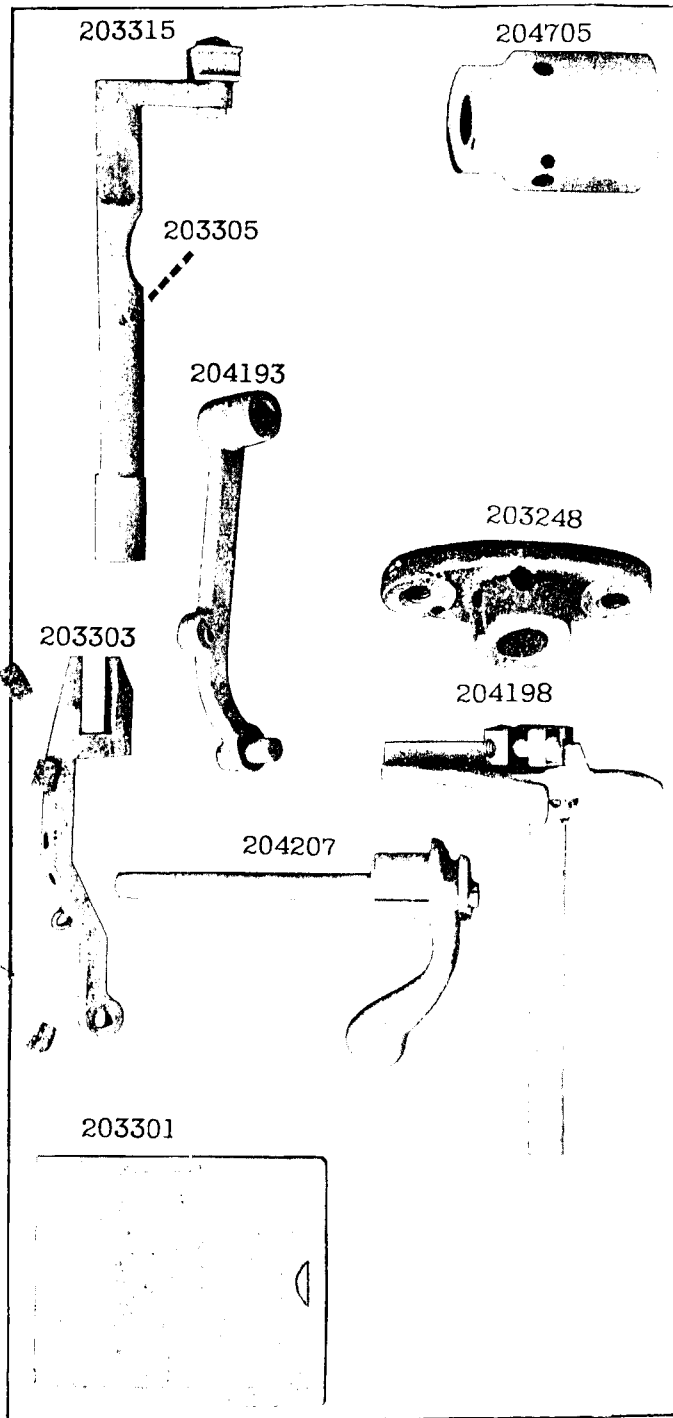


PLATE 12338—FULL SIZE

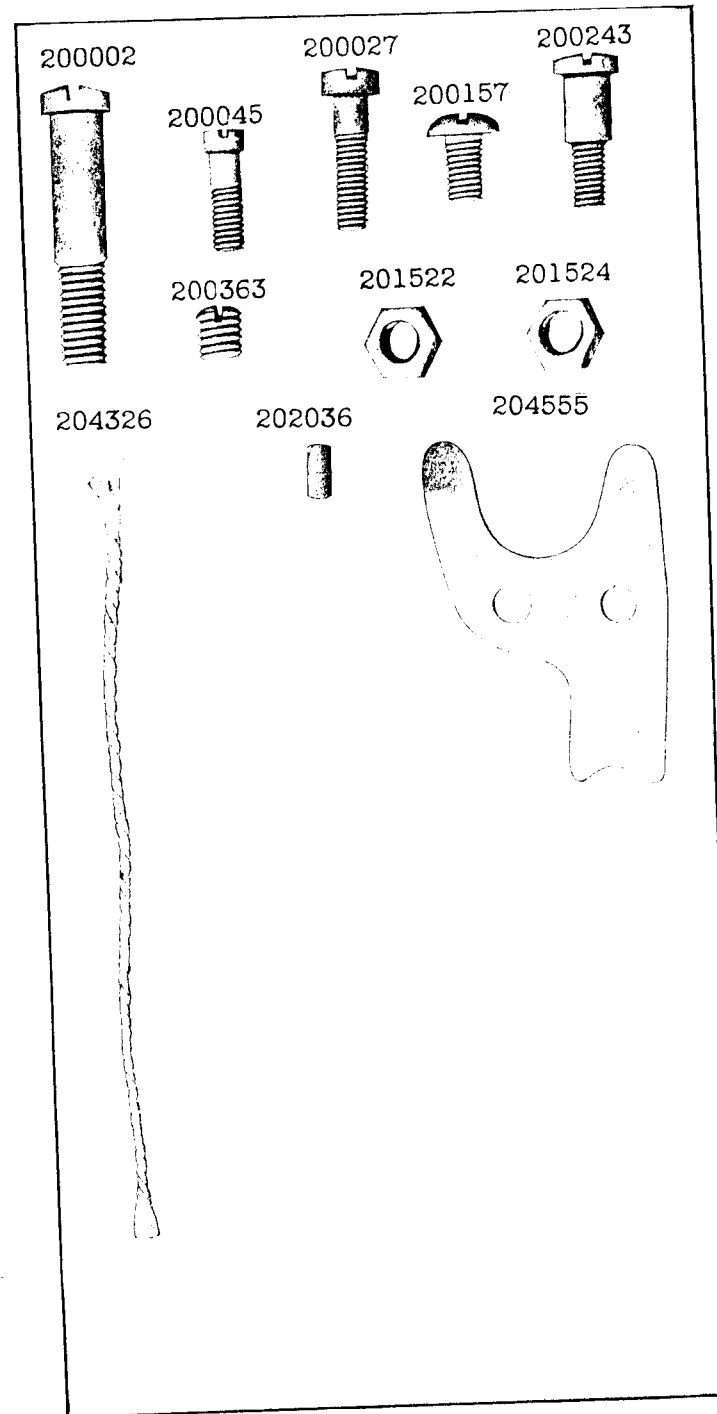
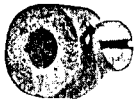


PLATE 12388—FULL SIZE

227227



202784



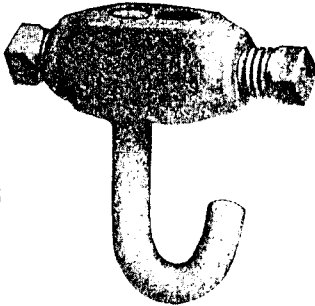
206628



225016



227576

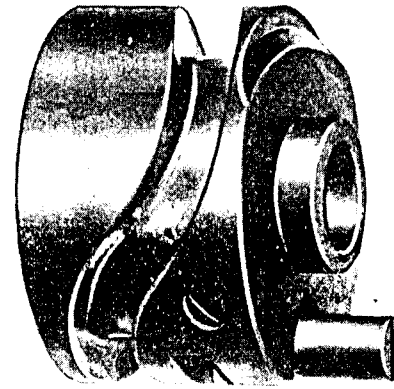


227316



PLATE 13045—FULL SIZE

213006



213141



204258



200548



203214



204235



200382



201253



200984



200594



201376



PLATE 13104—FULL SIZE

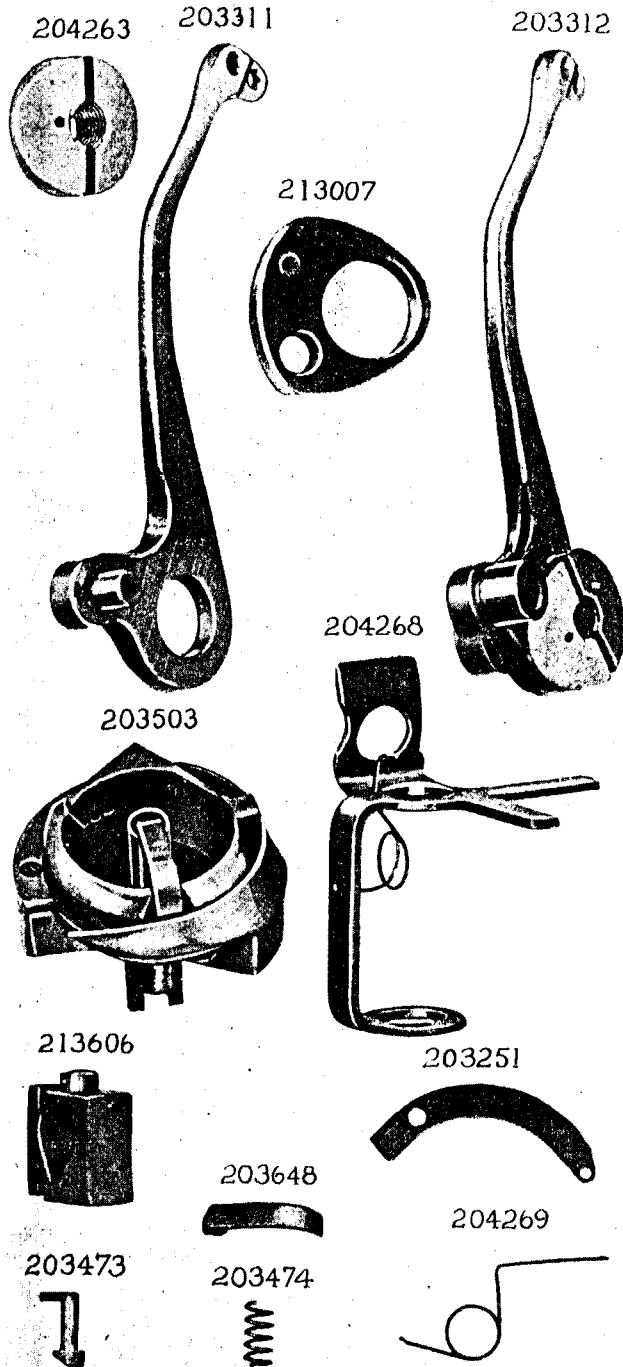
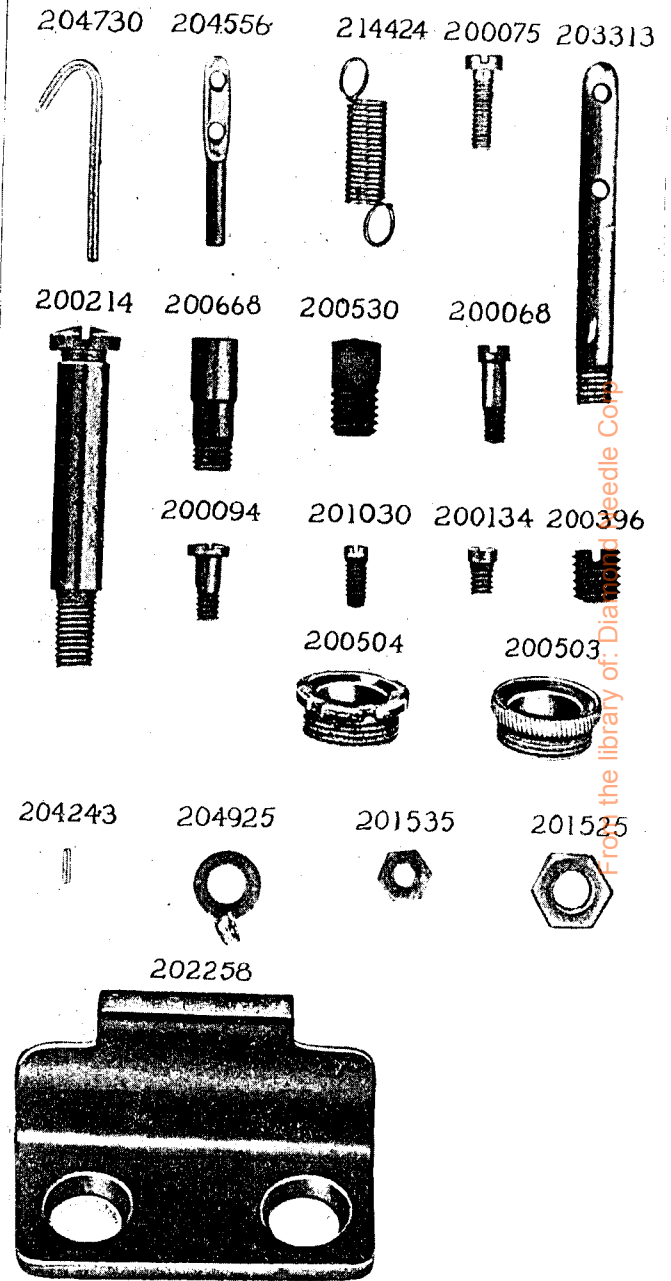


PLATE 13105—FULL SIZE



From the library of: Diamond Seedle Corp

PLATE 13106—FULL SIZE

212100



212103



212104



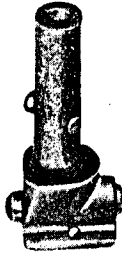
211650



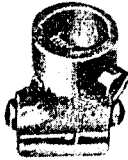
212179



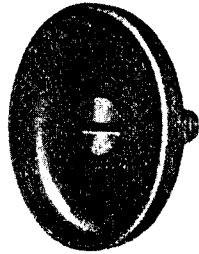
231381



203701



201907



229339



229329

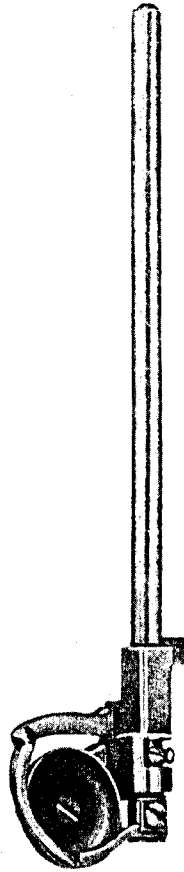


213699

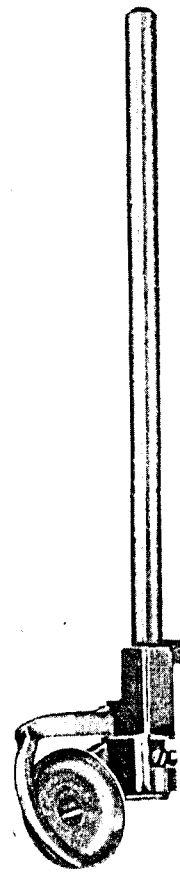


PLATE 13107—ONE-HALF SIZE

229345



229748



227307



41400



From the library of: Diamond Needle Corp